

EQ3 SynScan INSTALLATION

CONTENTS

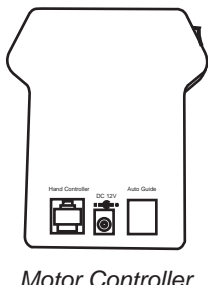
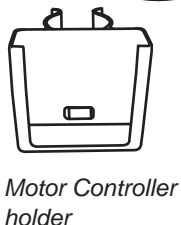
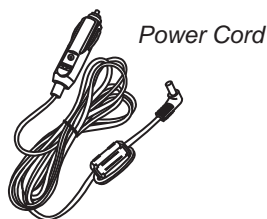

SETTING UP

- 1) Locate the hand control holder. Slide the holder onto the accessory tray as shown in Fig.1.
- 2) Point the mount to the North, or South in the Southern Hemisphere. Clip the motor controller holder onto the leg that's on the right hand side of the mount, as seen in Fig.2.
- 3) Slide the motor controller into the holder, as seen in Fig.3
- 4) Rotate the mount in Dec axis so that the Dec motor is on the same side of the receptacles of the mount, as seen in Fig.4.

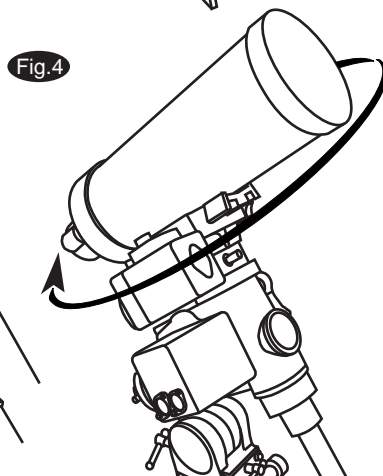
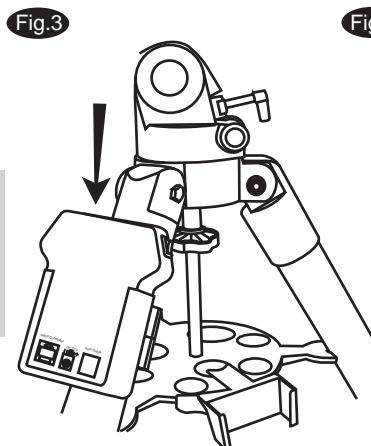
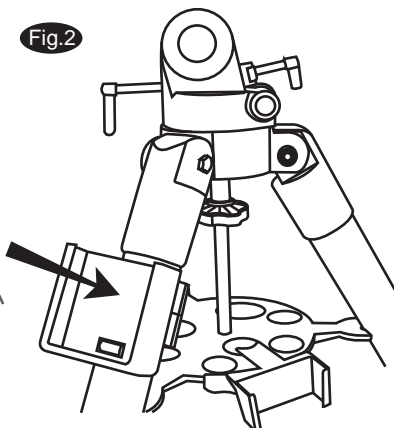
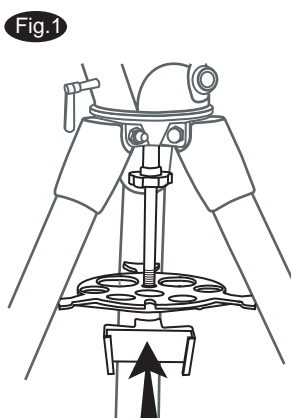

To avoid potential electronic-magnetic interference to other devices, the motor controller holder must be clipped firmly onto the stainless leg and the motor controller must be fully slid into the holder.

CONNECTING THE CABLES

- 5) Locate the short motor cable. Plug one end of the cable into the receptacle labeled "Dec.IN", and the other into the the receptacle labeled "Dec. OUT" on the mount. (Fig.5)
- 6) Locate the long motor cable. Plug one end of the cable into the motor controller and the other into the receptacle labeled "R.A. IN" on the mount. (Fig.6)
- 7) The hand control cable has a RJ-45 connector on both ends. Plug one end into the hand control and the other into the outlet on the motor controller.
- 8) Locate the power cord. Make sure that the power switch on the motor controller is OFF. Plug the cigarette lighter end of the cable into the battery and the other into the motor controller.

