



NexStar[®] 5SE

INSTRUCTION MANUAL

INTRODUCTION	4
WARNING	4
ASSEMBLY	6
ASSEMBLING THE NEXSTAR	6
<i>Powering the NexStar</i>	6
<i>The Hand Control</i>	6
<i>The Star Diagonal</i>	7
<i>The Eyepiece</i>	7
<i>The Star Pointer Finderscope</i>	7
<i>Removing the Optical Tube</i>	8
<i>Attaching the NexStar to the Tripod</i>	9
HAND CONTROL	10
HAND CONTROL OPERATION	11
<i>Alignment Procedure</i>	11
<i>Sky Align</i>	12
<i>Auto Two-Star Align</i>	13
<i>Two Star Alignment</i>	14
<i>One-Star Align</i>	14
<i>Solar System Align</i>	15
IMPROVING POINTING ACCURACY	16
<i>Alignment Stars:</i>	16
<i>Sync:</i>	17
<i>Undo Sync:</i>	17
OBJECT CATALOG	17
<i>Selecting an Object</i>	17
<i>Slewing to an Object</i>	18
<i>Finding Planets</i>	18
<i>Tour Mode</i>	18
<i>Constellation Tour</i>	18
DIRECTION BUTTONS	19
<i>Rate Button</i>	19
SETUP PROCEDURES	19
<i>Tracking Mode</i>	19
<i>Tracking Rate</i>	19
<i>View Time-Site</i>	20
<i>User Defined Objects</i>	20
CAMERA –	20
<i>Connecting Camera</i>	21
<i>Controlling Camera</i>	21
<i>Camera Wizard</i>	21
GET RA/DEC -	22
GOTO R.A/ DEC	22
IDENTIFY	22
PRECISE GOTO	22
SCOPE SETUP FEATURES	23
<i>Setup Time-Site</i>	23
<i>Anti-backlash</i>	23
<i>Slew Limits</i>	23

<i>Filter Limits</i>	23
<i>Direction Buttons</i>	23
<i>Goto Approach</i>	23
<i>Cordwrap</i>	24
UTILITY FEATURES	24
Wedge Align	24
<i>GPS On/Off</i>	24
<i>Light Control</i>	24
<i>Factory Setting</i>	24
Version	24
<i>Get Axis Position</i>	24
<i>Goto Axis Postion</i>	24
Hibernate	24
Sun Menu.....	24
Scrolling Menu	25
Calibrate Goto	25
Set Mount Position	25
<i>Hand Control Command Tree</i>	26
TELESCOPE BASICS.....	26
<i>Image Orientation</i>	27
<i>Focusing</i>	28
CALCULATING MAGNIFICATION	28
DETERMINING FIELD OF VIEW	28
GENERAL OBSERVING HINTS	29
THE CELESTIAL COORDINATE SYSTEM	30
MOTION OF THE STARS	31
POLAR ALIGNMENT	32
<i>Photography with the NexStar</i>	33
<i>Finding the North Celestial Pole</i>	34
CELESTIAL OBSERVING	35
OBSERVING THE MOON.....	35
OBSERVING THE PLANETS.....	35
OBSERVING THE SUN	35
OBSERVING DEEP SKY OBJECTS	36
SEEING CONDITIONS	36
<i>Transparency</i>	36
<i>Sky Illumination</i>	36
<i>Seeing</i>	36
TELESCOPE MAINTENANCE.....	37
<i>Care and Cleaning of the Optics</i>	37
<i>Collimation</i>	37
APPENDIX A - TECHNICAL SPECIFICATIONS.....	41
APPENDIX B - GLOSSARY OF TERMS.....	42
APPENDIX C – RS 232 CONNECTION	44
APPENDIX D – MAPS OF TIME ZONES.....	45
SKY MAPS.....	47



Introduction

Congratulations on your purchase of the Celestron NexStar! The NexStar ushers in a whole new generation of computer automated technology. Simple and friendly to use, the NexStar is up and running after locating just three bright objects. It's the perfect combination of power and portability. If you are new to astronomy, you may wish to start off by using the NexStar's built-in Sky Tour feature, which commands the NexStar to find the most interesting objects in the sky and automatically slews to each one. Or if you are an experienced amateur, you will appreciate the comprehensive database of nearly 40,000 objects, including customized lists of all the best deep-sky objects, bright double stars and variable stars. No matter at what level you are starting out, the NexStar will unfold for you and your friends all the wonders of the Universe.

Some of the many standard features of the NexStar include:

- Incredible 4°/second slew speed.
- Fully enclosed motors and optical encoders for position location.
- Integrated hand controller – built into the side of the fork arm.
- Storage for programmable user defined objects; and

Many other high performance features!

The NexStar's deluxe features combined with Celestron's legendary optical standards give amateur astronomers one of the most sophisticated and easy to use telescopes available on the market today.

Take time to read through this manual before embarking on your journey through the Universe. It may take a few observing sessions to become familiar with your NexStar, so you should keep this manual handy until you have fully mastered your telescope's operation. The NexStar hand control has built-in instructions to guide you through all the alignment procedures needed to have the telescope up and running in minutes. Use this manual in conjunction with the on-screen instructions provided by the hand control. The manual gives detailed information regarding each step as well as needed reference material and helpful hints guaranteed to make your observing experience as simple and pleasurable as possible.

Your NexStar telescope is designed to give you years of fun and rewarding observations. However, there are a few things to consider before using your telescope that will ensure your safety and protect your equipment.

Warning



- ❑ **Never look directly at the sun with the naked eye or with a telescope (unless you are using the proper solar filter). Permanent and irreversible eye damage may result.**
- ❑ Never use your telescope to project an image of the sun onto any surface. Internal heat build-up can damage the telescope and any accessories attached to it.
- ❑ Never use an eyepiece solar filter or a Herschel wedge. Internal heat build-up inside the telescope can cause these devices to crack or break, allowing unfiltered sunlight to pass through to the eye.
- ❑ Never leave the telescope unsupervised, either when children are present or adults who may not be familiar with the correct operating procedures of your telescope.

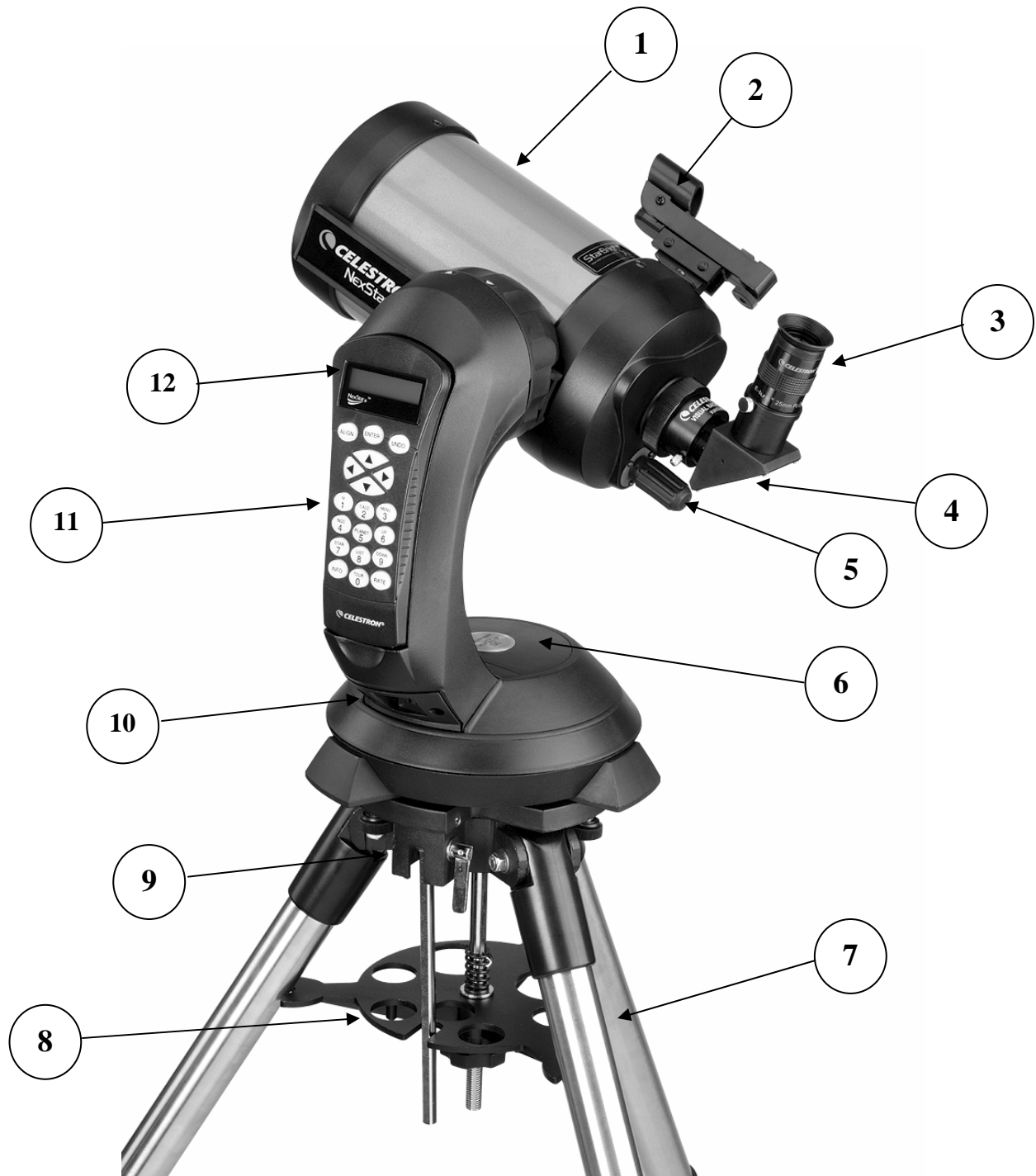

1	Optical Tube	7	Tripod
2	Star Pointer Finderscope	8	Accessory Tray / Leg Brace
3	Eyepiece	9	Tilt Wedge Plate
4	Star Diagonal	10	ON/OFF Switch
5	Focuser Knob	11	Hand Control
6	Battery Compartment	12	Liquid Crystal Display

NexStar 5 SE

CELESTRON Assembly

The NexStar 5 comes completely pre-assembled and can be operational in a matter of minutes. The NexStar is conveniently packaged in one reusable shipping carton that contains all of the following accessories:

- 25mm Eyepiece – 1¼"
- Star Diagonal 1¼"
- Star Pointer Finderscope
- Steel Tripod with built-in Wedge
- The Sky™ Level 1 Astronomy Software
- NexRemote telescope control software
- RS232 Cable
- Camera Shutter Cable
- Computerized Hand Control with nearly 40,000 Object Database

Assembling the NexStar

Start by removing the telescope from its shipping carton and setting the round base on a flat table or surface. It is best to carry the telescope by holding it from the lower portion of the fork arm and from the bottom of the base. Remove all of the accessories from their individual boxes. Remember to save all of the containers so that they can be used to transport the telescope. Before the batteries can be installed, the telescope tube should be positioned horizontal to the ground. To do this, gently rotate the front of the tube upwards until it is level with the ground.

Powering the NexStar

The NexStar can be powered by eight AA batteries (not included), an optional 12v AC adapter or an optional car battery adapter. The battery compartment is located in the center of the telescope's base (see figure 3-1).

To power the NexStar with batteries:

1. Remove the battery cover from the center of the base by gently lifting up on the round portion of the cover.
2. Insert the batteries into the battery compartment of the base.
3. Reattach the battery compartment door by gently pushing down on the cover until it snaps into place.
4. Turn on the power to the NexStar by flipping the switch, located at the base of the fork arm, to the "On" position.

The Hand Control

The hand control is located on the side of the fork arm and can be removed and used remotely or used while attached to the fork. The hand control attaches to the fork arm by resting on two posts, located on the bottom of the hand control cradle, and a clip inside the fork arm. To remove the hand control from the fork arm cradle, gently lift the hand control upwards and pull out. To return the hand control into the fork arm, lower the hand control into the cradle so that the two holes in the bottom of the hand control go over the posts on the bottom of the cradle, and the opening in the back of the hand control slides over the clip inside the fork arm.

Once the telescope is powered up, the hand control can be used to move the optical tube in altitude (up and down) and azimuth (side to side). Use the Up arrow directional button to move the telescope tube until it is roughly parallel to the ground. This will

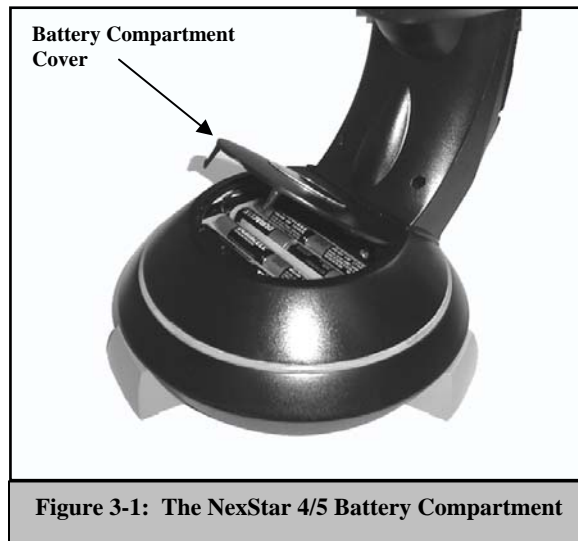

Figure 3-1: The NexStar 4/5 Battery Compartment

make it more convenient to attach the necessary accessories as well as remove the front lens cover and install batteries when they are needed.

You are now ready to attach the included visual accessories onto the telescope optical tube.

The Star Diagonal

The star diagonal diverts the light at a right angle from the light path of the telescope. For astronomical observing, this allows you to observe in positions that are more comfortable than if you were to look straight through. To attach the star diagonal:

1. Turn the thumbscrew on the visual back until its tip no longer extends into (i.e., obstructs) the inner diameter of the visual back.
2. Slide the chrome portion of the star diagonal into the visual back.
3. Tighten the thumbscrew on the visual back to hold the star diagonal in place.

If you wish to change the orientation of the star diagonal, loosen the thumbscrew on the visual back until the star diagonal rotates freely. Rotate the diagonal to the desired position and tighten the thumbscrew.

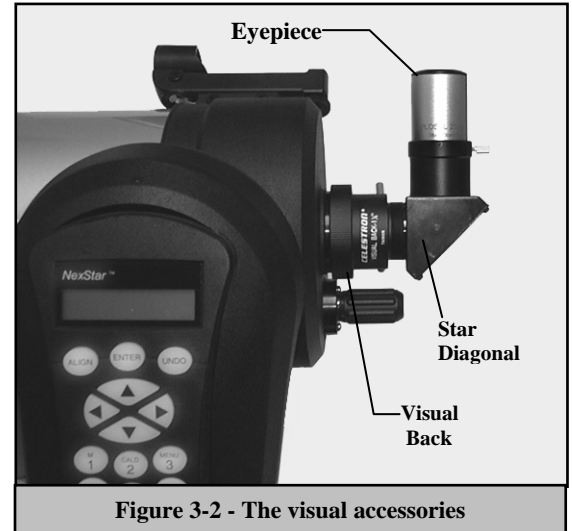

Figure 3-2 - The visual accessories

The Eyepiece

The eyepiece, or ocular, is the optical element that magnifies the image focused by the telescope. The eyepiece fits into either the visual back directly or the star diagonal. To install the eyepiece:

1. Loosen the thumbscrew on the star diagonal so it does not obstruct the inner diameter of the eyepiece end of the diagonal.
2. Slide the chrome portion of the eyepiece into the star diagonal.
3. Tighten the thumbscrew to hold the eyepiece in place.

To remove the eyepiece, loosen the thumbscrew on the star diagonal and slide the eyepiece out.

Eyepieces are commonly referred to by focal length and barrel diameter. The focal length of each eyepiece is printed on the eyepiece barrel. The longer the focal length (i.e., the larger the number) the lower the eyepiece power or magnification; and the shorter the focal length (i.e., the smaller the number) the higher the magnification. Generally, you will use low-to-moderate power when viewing. For more information on how to determine power, see the section on “Calculating Magnification.”

Barrel diameter is the diameter of the barrel that slides into the star diagonal or visual back. The NexStar uses eyepieces with a standard 1-1/4" barrel diameter.

The Star Pointer Finderscope

The Star Pointer is the quickest and easiest way to point your telescope exactly at a desired object in the sky. It's like having a laser pointer that you can shine directly onto the night sky. The Star Pointer is a zero magnification pointing tool that uses a coated glass window to superimpose the image of a small red dot onto the night sky. While keeping both eyes open when looking through the Star Pointer, simply move your telescope until the red dot, seen through the Star Pointer, merges with the object as seen with your unaided eye. The red dot is produced by a light-emitting diode (LED); it is not a laser beam and will not damage the glass window or your eye. The Star Pointer comes equipped with a variable brightness control, two axes alignment control and a quick-release dovetail mounting bracket. Before the Star Pointer is ready to be used, it must be attached to the telescope tube and properly aligned:

Star Pointer Installation

1. Locate the dovetail mounting bracket on the rear cell of the optical tube.

- Slide the mounting track at the bottom of the Star Pointer over the dovetail portion of the bracket. It may be necessary to loosen the two screws on the side of the mounting track before sliding it over the dovetail. The end of the Star Pointer with the glass window should be facing out towards the front of the telescope.
- Tighten the two screws on the side of the mounting track to secure the Star Pointer to the dovetail bracket.

Star Pointer Operation

The star pointer is powered by a long life 3-volt lithium battery (#CR2032) located underneath the front portion of the Star Pointer. Like all finderscopes, the Star Pointer must be properly aligned with the main telescope before it can be used. This is a simple process using the azimuth and altitude control knobs located on the side and bottom of the Star Pointer. The alignment procedure is best done at night since the LED dot will be difficult to see during the day.

- To turn on the Star Pointer, rotate the variable brightness control (see figure 3-3) clockwise until you here a "click". To increase the brightness level of the red dot, continue rotating the control knob about 180° until it stops. **Remember to remove the plastic cover over the battery, and always turn the power off after you have found an object. This will extend the life of both the battery and the LED.**

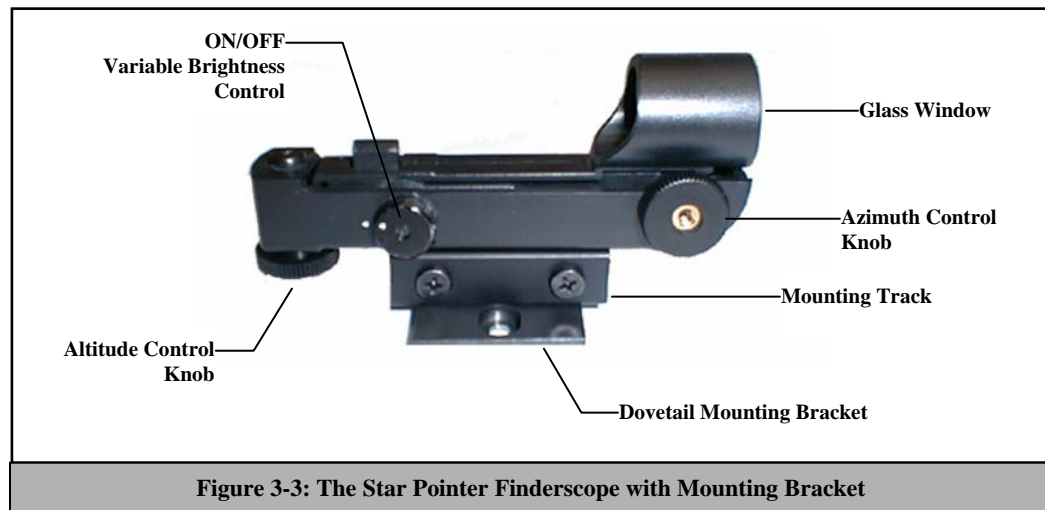

Figure 3-3: The Star Pointer Finderscope with Mounting Bracket

- Locate a bright star or planet and center it in a low power eyepiece in the main telescope.
- With both eyes open, look through the glass window at the alignment star.
- If the Star Pointer is perfectly aligned, you will see the red LED dot overlap the alignment star. If the Star Pointer is not aligned, take notice of where the red dot is relative to the bright star.
- Without moving the main telescope, turn the Star Pointer's azimuth and altitude alignment controls until the red dot is directly over the alignment star.

If the LED dot is brighter than the alignment star, it may make it difficult to see the star. Turn the variable brightness control counterclockwise, until the red dot is the same brightness as the alignment star. This will make it easier to get an accurate alignment. The Star Pointer is now ready to be used.

Removing the Optical Tube

The NexStar SE dovetailed quick release bracket that allows you to adjust the optical tube for proper balancing or remove the tube for safe storage. To adjust or remove the tube from that base, simply loosen the quick release clamp knob (see figure 3-4) and slide the tube back towards the rear cell of the tube.

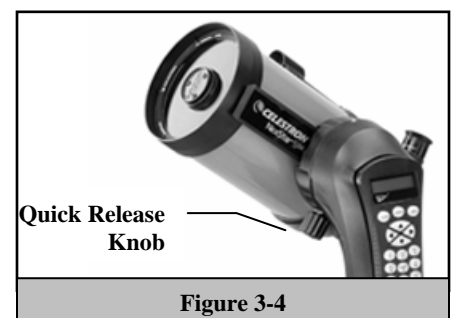

Figure 3-4

Attaching the NexStar to the Tripod

The Celestron NexStar tripod is a sturdy, heavy duty mount on which to place your NexStar 4/5" telescope. This tripod can go anywhere, from your backyard to a remote observing site and can hold your NexStar in Alt-Az or can be polar aligned with the use of the built-in equatorial wedge tilt plate. The tripod comes completely assembled and only needs to have the center leg brace / accessory tray put in place.

To set up the tripod:

1. Hold the tripod with the head up, away from the ground.
2. Pull the legs apart until the legs are fully extended and press it down flat against the ground.
3. Place the center leg brace over the center support rod so that the slotted cutout is directly under the latitude adjustment rod.
4. Tighten with the leg brace locking knob until the leg brace firmly presses out against each leg.
5. The tripod will now stand by itself.

Your tripod has height adjustable legs for proper leveling on all types of surfaces. The tripod also comes with detached bubble level to assist in accurate leveling. To adjust the height and level the tripod:

1. Place the bubble level on the top of the tripod tilt plate. Make sure that the tilt plate is all the way down and horizontal to the ground.
2. Locate the tightening screw on the bottom of each tripod leg.
3. Rotate the knob counterclockwise until the inside portion of the tripod leg slides out.
4. Extend the center portion of the tripod leg to the desired height making sure that the bubble in the bubble level is centered..
5. Tighten the knob to hold the tripod leg in place.

If polar aligning your telescope, it is best to adjust the latitude of the wedge tilt plate before mounting the telescope:

1. Loosen the latitude locking lever (located next to the latitude adjustment rod) and raise the wedge tilt plate until the scale on the latitude adjustment rod is the same as the latitude of your observing site.
2. Tighten the locking lever to hold the tilt plate securely in place.
3. Set the base of the telescope on the wedge tilt plate so that the hole in the center of the base goes over the positioning pin on top of the tilt plate.
4. Rotate the base so the holes under each rubber foot line up with the mounting bolts attached to the tilt plate.
5. First thread in the mounting bolt closest to the latitude adjustment rod, then align the other two holes and thread in the remaining mounting bolts. Check that the latitude locking lever is still locked down tight.

Your NexStar is now securely attached to the tripod and ready for use.



CELESTRON Hand Control

The NexStar has a removable hand controller built into the side of the fork arm designed to give you instant access to all the functions the NexStar has to offer. With automatic slewing to nearly 40,000 objects, and common sense menu descriptions, even a beginner can master its variety of features in just a few observing sessions. Below is a brief description of the individual components of the NexStar hand controller:

1. **Liquid Crystal Display (LCD) Window:** Has a dual-line, 16 character display screen that is backlit for comfortable viewing of telescope information and scrolling text.
2. **Align:** Instructs the NexStar to use a selected star or object as an alignment position.
3. **Direction Keys:** Allows complete control of the NexStar in any direction. Use the direction keys to center objects in the StarPointer finderscope and eyepiece.

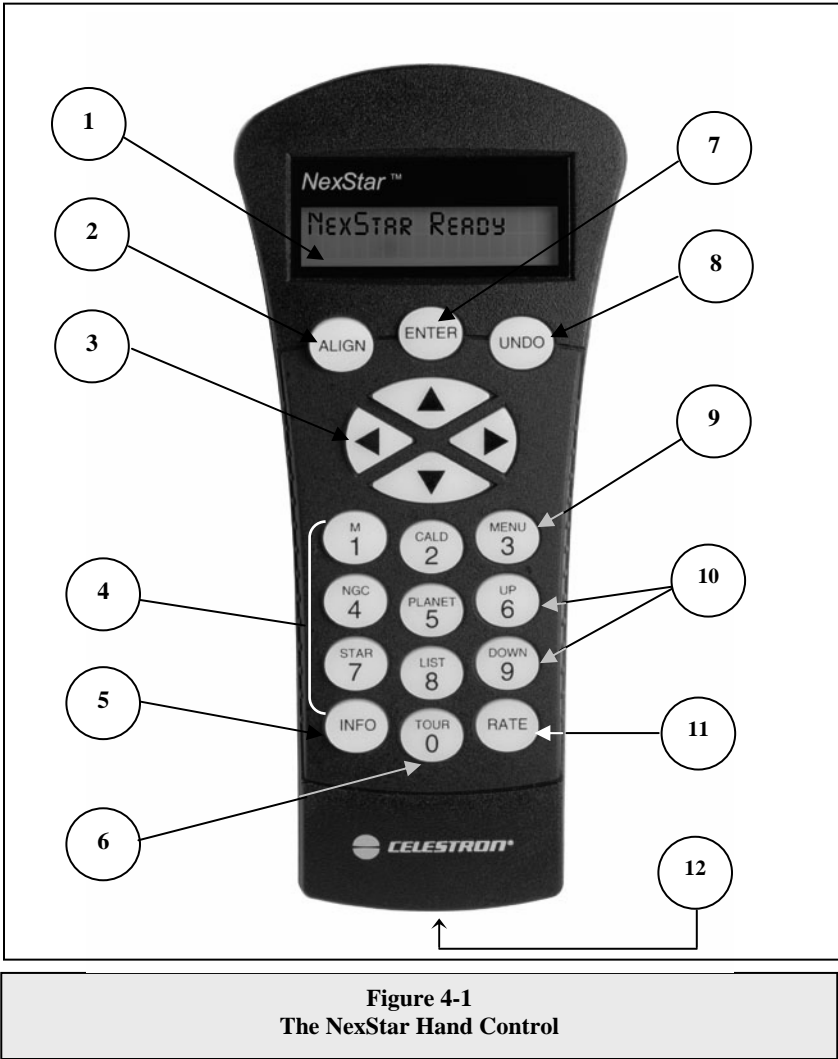

Figure 4-1
The NexStar Hand Control

4. **Catalog Keys:** The NexStar has a key on the hand control to allow direct access to each of the catalogs in its 40,000 object database. The NexStar contains the following catalogs in its database:
- Messier** – Complete list of all Messier objects.
 - NGC** – Select list of all the deep-sky objects in the Revised New General Catalog.
 - Caldwell** – A combination of the best NGC and IC objects.
 - Planets** - All 8 planets in our Solar System plus the Moon.
 - Stars** – A compiled list of the brightest stars from the SAO catalog.
 - List** – For quick access, all of the best and most popular objects in the NexStar database have been broken down into lists based on their type and/or common name:

Named Stars	Common name listing of the brightest stars in the sky.
Named Objects	Alphabetical listing of over 50 of the most popular deep sky objects.
Double Stars	Numeric-alphabetical listing of the most visually stunning double, triple and quadruple stars in the sky.
Variable Stars	Select list of the brightest variable stars with the shortest period of changing magnitude.
Asterisms	A unique list of some of the most recognizable star patterns in the sky.

5. **Info:** Displays coordinates and useful information about objects selected from the NexStar database.
6. **Tour:** Activates the tour mode, which seeks out all the best objects for a given month and automatically slews the NexStar to those objects.
7. **Enter:** Pressing *Enter* allows you to select any of the NexStar functions, accept entered parameters and slew the telescope to displayed objects.
8. **Undo:** *Undo* will take you out of the current menu and display the previous level of the menu path. Press *Undo* repeatedly to get back to a main menu or use it to erase data entered by mistake.
9. **Menu:** Displays the many setup and utilities functions such as tracking rate and user defined objects and many others.
10. **Scroll Keys:** Used to scroll up and down within any of the menu lists. A double arrow symbol on the right side of the LCD indicates that the scroll keys can be used to view additional information.
11. **Rate:** Instantly changes the rate of speed of the motors when the direction buttons are pressed.
12. **RS-232 Jack:** Allows you to interface with a computer and control the NexStar remotely.

Hand Control Operation

This section describes the basic hand control procedures needed to operate the NexStar. These procedures are grouped into three categories: Alignment, Setup and Utilities. The alignment section deals with the initial telescope alignment as well as finding objects in the sky; the setup section discusses changing parameters such as tracking mode and tracking rate; finally, the last section reviews all of the utility functions such as adjusting the telescopes slew limits and backlash compensation.

Alignment Procedure

In order for the NexStar to accurately point to objects in the sky, it must first be aligned to known positions (stars) in the sky. With this information, the telescope can create a model of the sky, which it uses to locate any object with known coordinates. There are many ways to align the NexStar with the sky depending on what information the user is able to provide: **SkyAlign** uses your current date, time and city to create an accurate model of the sky. Then the user can simply point the telescope to any three bright celestial objects to accurately align the telescope with the sky. **Auto Two-Star Align** will ask the user to choose and center the first alignment star, then the NexStar will automatically select and slew to a second star for alignment. **Two-Star Alignment** requires the user to identify and manually slew the telescope to the two alignment stars. **One-Star Align** is the same as Two-Star Align however only requires you to align to one known star. Although not as accurate as the other alignment methods, **One-Star Align** is the quickest way to find and track bright planets and objects in Altazimuth mode. **Solar System Align** will display a list of visible daytime objects (planets and the moon) available to align the

Definition

"Altazimuth" or "Alt-Az" refers to a type of mounting that allows a telescope to move in both altitude (up and down) and azimuth (left and right) with respect to the ground. This is the simplest form of mounting in which the telescope is attached directly to a tripod.

telescope. Finally, **EQ North and EQ South** alignments are designed to assist you in aligning the NexStar when polar aligned using the tripods built-in wedge. Each alignment method is discussed in detail below.

Sky Align

Sky Align is the easiest way to get your NexStar aligned and ready to observe. Even if you do not know a single star in the sky, the NexStar will have you aligned in minutes by asking for basic information like the date, time and location. Then you simply need to aim the telescope to any three bright celestial objects in the sky. Since Sky Align requires no knowledge of the night sky it is not necessary to know the name of the stars at which you are aiming. You may even select a planet or the moon. The NexStar is then ready to start finding and tracking any of the objects in its object database. Before the telescope is ready to be aligned, it should be set up in an outside location with all accessories (eyepiece, diagonal and finderscope) attached and lens cover removed. Also make sure that the tripod is leveled as described in the Assembly section of the manual. To begin Sky Align:

1. Power on the NexStar by flipping the switch located at the base of the fork are to the “on” position.
2. Press ENTER to choose *Sky Align*. Pressing the ALIGN key will bypass the other alignment options and the scrolling text and automatically begins *Sky Align*.
3. The hand control display will then ask for the following time/site information:

Location - The NexStar will display a list of cities to choose from. Choose the city from the database that is closest to your current observing site. The city you choose will be remembered in the hand controls memory so that it will be automatically displayed the next time an alignment is done. Alternatively, if you know the exact longitude and latitude of your observing site, it can be entered directly into the hand control and remembered for future use as well. To choose a location city:

- ❑ Use the Up and Down scroll keys to choose between *City Database* and *Custom Site*. *City Database* will allow you to select the closest city to your observing site from a list of either international or U.S. location. *Custom Site* allows you to enter the exact longitude and latitude of your observing site. Select *City Database* and press ENTER.
- ❑ The hand control will allow you to choose from either U.S. or international locations. For a listing of U.S. locations by state and then by city, press ENTER while **United States** is displayed. For international locations, use the Up or Down scroll key to select **International** and press ENTER.
- ❑ Use the Up and Down Scroll buttons to choose your current state (or country if International locations was selected) from the alphabetical listing and press ENTER.
- ❑ Use the Up and Down Scroll buttons to choose the closest city to your location from the displayed list and press ENTER.

Time - Enter the current time for your area. You can enter either the local time (i.e. 8:00), or you can enter military time (i.e. 20:00).

- ❑ Select PM or AM. If military time was entered, the hand control will bypass this step.
- ❑ Choose between Standard time or Daylight Savings time. Use the Up and Down scroll buttons (10) to toggle between options.
- ❑ Select the time zone that you are observing from. Again, use the Up and Down buttons (10) to scroll through the choices. For time zone information, refer to the Time Zone map in the appendix of this manual.

Date - Enter the month, day and year of your observing session. The display will read: mm/dd/yy -

-If the wrong information has been input into the hand control, the UNDO button will act as a backspace allowing the user to re-enter information.

Helpful Hints

-The next time that your NexStar is aligned, the hand control will automatically display the last location (either a city or longitude/latitude) that was entered. Press ENTER to accept these parameters if they still apply. Pressing the UNDO button will allow you to go back and select a new city location or longitude/latitude.

4. Use the arrow buttons on the hand control to slew (move) the telescope towards any bright celestial object in the sky. Align the object with the red dot of the finderscope and press ENTER.
5. If the finderscope has been properly aligned with the telescope tube, the alignment star should now be visible inside the field of view of the eyepiece. The hand control will ask that you center the bright alignment star in the center of the eyepiece and press the ALIGN button. This will accept the star as the first alignment position. (There is no need to adjust the slewing rate of the motors after each alignment step. The NexStar automatically selects the best slewing rate for aligning objects in both the finderscope and the eyepiece).
6. For the second alignment object, choose a bright star or planet as far as possible from the first alignment object. Once again use the arrow button to center the object in the finderscope and press ENTER. Then once centered in the eyepiece press the ALIGN button.
7. Repeat the process for the third alignment star. When the telescope has been aligned to the final stars, the display will read "**Match Confirmed**". Press UNDO to display the names of the three bright objects you aligned to, or press ENTER to accept these three objects for alignment. You are now ready to find your first object.

Tips for Using Sky Align

Remember the following alignment guidelines to make using Sky Align as simple and accurate as possible.

- Be sure to level the tripod before you begin alignment. The time/site information along with a level tripod will help the telescope better predict the available bright stars and planets that are above the horizon.
- Remember to select alignment stars that are as far apart in the sky as possible. For best results make sure that the third alignment star does not lie in a straight line between the first two stars. This may result in a failed alignment.
- Don't worry about confusing planets for stars when selecting alignment objects. SkyAlign works with the four brightest planets (Venus, Jupiter, Saturn and Mars) as well as the Moon. In addition to the planets, the hand control has over 80 bright alignment stars to choose from (down to 2.5 magnitude).
- Rarely SkyAlign will not be able to determine what three alignment objects were centered. This sometime happens when a bright planet or the Moon passes near one of the brighter stars. In situations like these it is best to try to avoid aligning to either object if possible.
- Be sure to center the objects with the same final movements as the direction of the GoTo Approach. For example, if the scope normally finishes a GoTo with the front of the scope moving right and up, you should center all three alignment objects in the eyepiece using the right and up arrow buttons (the up/down arrows reverse at slew rates of 6 or lower). Approaching the star from this direction when looking through the eyepiece will eliminate much of the backlash between the gears and assure the most accurate alignment possible.

Auto Two-Star Align

As with Sky Align, Auto Two-Star Align requires you to enter all the necessary time/site information as before. Once this information is entered, NexStar will prompt you to select and point the telescope at one known star in the sky. The NexStar now has all the information it needs to automatically choose a second star that will assure the best possible alignment. Once selected the telescope will automatically slew to that second alignment star to complete the alignment. With the NexStar set up outside with all accessories attached and the tripod leveled, follow the steps below to align the telescope:

1. Once the NexStar is powered on, Press ENTER to begin alignment.
2. Use the Up and Down scroll keys (10) to select *Auto Two-Star Align* and press ENTER.
3. The hand control will display the last time and location information that was entered into the hand control. Use the Up and Down buttons to scroll through the information. Press ENTER to accept the current information or press UNDO to manually edit the information (see Sky Align section for detailed instruction on entering time/site information).
4. The display will now prompt you to select a bright star from the displayed list on the hand control. Use Up and Down buttons (6 and 9 on the keypad) to scroll to the desired star and then press ENTER.
5. Use the arrow buttons to slew the telescope to the star you selected. Center the star in the finderscope and press ENTER. Finally, center the star in the eyepiece and press ALIGN.

6. Based on this information, the NexStar will automatically display the most suitable second alignment star that is above the horizon. Press ENTER to automatically slew the telescope to the displayed star. If for some reason you do not wish to select this star (perhaps it is behind a tree or building), you can either:
 - Press the UNDO button to display the next most suitable star for alignment.
 - Use the UP and DOWN scroll buttons to manually select any star you wish from the entire list of available stars.

Once finished slewing, the display will ask you to use the arrow buttons to align the selected star with the red dot of the finderscope. Once centered in the finder, press ENTER. The display will then instruct you to center the star in the field of view of the eyepiece. When the star is centered, press ALIGN to accept this star as your second alignment star. When the telescope has been aligned to both stars the display will read **Align Success**, and you are now ready to find your first object.

Two Star Alignment

With the two-star alignment method, the NexStar requires the user to know the positions of two bright stars in order to accurately align the telescope with the sky and begin finding objects. Here is an overview of the two-star alignment procedure:

1. Once the NexStar is powered on, use the Up and Down scroll keys (10) to select Two-Star Align, and press ENTER.
2. Press ENTER to accept the time/site information displayed on the display, or press UNDO to enter new information.
3. The SELECT STAR 1 message will appear in the top row of the display. Use the Up and Down scroll keys (10) to select the star you wish to use for the first alignment star. Press ENTER.
4. NexStar then asks you to center in the eyepiece the alignment star you selected. Use the direction arrow buttons to slew the telescope to the alignment star and carefully center the star in the finderscope. Press ENTER when centered.
5. Then, center the star in the eyepiece and press ALIGN.



**Helpful
Hint**

In order to accurately center the alignment star in the eyepiece, you may wish to decrease the slew rate of the motors for fine centering. This is done by pressing the RATE key (11) on the hand controller then selecting the number that corresponds to the speed you desire. (9 = fastest , 1 = slowest).

6. NexStar will then ask you to select and center a second alignment star and press the ALIGN key. It is best to choose alignment stars that are a good distance away from one another. Stars that are at least 40° to 60° apart from each other will give you a more accurate alignment than stars that are close to each other.

Once the second star alignment is completed properly, the display will read **Align Successful**, and you should hear the tracking motors turn-on and begin to track.

One-Star Align

One-Star Align requires you to input all the same information as you would for the Two-Star Align procedure. However, instead of slewing to two alignment stars for centering and alignment, the NexStar uses only one star to model the sky based on the information given. This will allow you to roughly slew to the coordinates of bright objects like the moon and planets and gives the NexStar the information needed to track objects in altazimuth in any part of the sky. One-Star Align is not meant to be used to accurately locate small or faint deep-sky objects or to track objects accurately for photography.

To use One-Star Align:

1. Select One-Star Align from the alignment options.
2. Press ENTER to accept the time/site information displayed on the display, or press UNDO to enter new information.
3. The SELECT STAR 1 message will appear in the top row of the display. Use the Up and Down scroll keys (10) to select the star you wish to use for the first alignment star. Press ENTER.
4. NexStar then asks you to center in the eyepiece the alignment star you selected. Use the direction arrow buttons to slew the telescope to the alignment star and carefully center the star in the finderscope. Press ENTER when centered.
5. Then, center the star in the eyepiece and press ALIGN.
6. Once in position, the NexStar will model the sky based on this information and display **Align Successful**.

Note: Once a One-Star Alignment has been done, you can use the Re-alignment feature (later in this section) to improve your telescope's pointing accuracy.

Solar System Align



Solar System Align is designed to provide excellent tracking and GoTo performance by using solar system objects (Sun, Moon and planets) to align the telescope with the sky. Solar System Align is a great way to align your telescope for daytime viewing as well as a quick way to align the telescope for night time observing.

Never look directly at the sun with the naked eye or with a telescope (unless you have the proper solar filter). Permanent and irreversible eye damage may result.

1. Select *Solar System Align* from the alignment options.
2. Press ENTER to accept the time/site information displayed on the display, or press UNDO to enter new information.
3. The SELECT OBJECT message will appear in the top row of the display. Use the Up and Down scroll keys (10) to select the daytime object (planet, moon etc) you wish to align. Press ENTER.
4. NexStar then asks you to center in the eyepiece the alignment object you selected. Use the direction arrow buttons to slew the telescope to the alignment object and carefully center it in the finderscope. Press ENTER when centered.
5. Then, center the object in the eyepiece and press ALIGN.

Once in position, the NexStar will model the sky based on this information and display **Align Successful**.

Tips for Using Solar System Align

- For safety purposes, the Sun will not be displayed in any of the hand control's customer object lists unless it is enabled from the Utilities Menu. To allow the Sun to be displayed on the hand control, do the following:
 1. Press the UNDO button until the display reads "NexStar SE"
 2. Press the MENU button and use the Up and Down keys to select the *Utilities menu*. Press ENTER.
 3. Use the UP and Down keys to select *Sun Menu* and press ENTER.
 4. Press ENTER again to allow the Sun to appear on the hand control display.

The Sun can be removed from the display by using the same procedure as above.

To improve the telescope pointing accuracy, you can use the Re-Align feature as described below.

EQ North / EQ South Alignment

EQ North and EQ South Alignments assist the user in aligning the telescope when polar aligned using the tripod's built-in equatorial wedge. Similar to the Altazimuth alignments described earlier, the EQ alignments gives you the choice of performing an AutoAlign, Two-Star alignment, One-Star alignment or Solar System alignment. For help in polar aligning your NexStar, see the Astronomy Basics section later in the manual.

EQ AutoAlign

The EQ AutoAlign uses all the same time/site information as the Alt-Az alignments, however it also requires you to position the tube so that the altitude index markers are aligned (see figure 4-2), and then rotate the telescope base until the tube is pointed towards the Meridian (see figure 4-3). Based on this information the NexStar will automatically slew to two selected alignment stars to be centered and aligned. To use EQ Auto-Align:

1. Select EQ North or South Align from the alignment options and press ENTER
2. Press ENTER to accept the time/site information displayed on the display, or press UNDO to enter the time/site information manually.
3. Select EQ AutoAlign method and press ENTER
4. With *Set Alt to Index* displayed on the hand control screen, use the up and down arrow buttons to move the telescope tube upwards until the altitude index markers are aligned. The altitude index markers are located at the top of the fork arm. See figure 4-2.
5. When *Find Meridian* is displayed on the hand control screen, use the left and right arrow buttons to move the telescope base until optical tube is pointing towards the Meridian.
6. Based on this information, the NexStar will automatically display the most suitable alignment stars that are above the horizon. Press ENTER to automatically

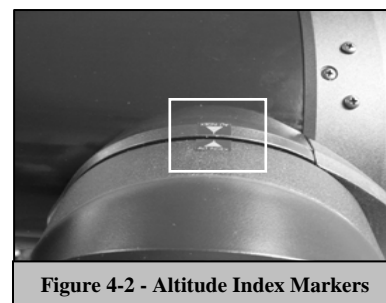

Figure 4-2 - Altitude Index Markers

slew the telescope to the displayed star. If for some reason you do not wish to select one of these stars (perhaps it is behind a tree or building), you can either:

- Press the UNDO button to display the next most suitable star for alignment.
 - Use the UP and DOWN scroll buttons to manually select any star you wish from the entire list of available stars.
7. The telescope then asks you to center in the eyepiece the alignment object you selected. Use the direction arrow buttons to slew the telescope to the alignment object and carefully center it in the finderscope. Press ENTER when centered.
 8. Then, center the object in the eyepiece and press ALIGN.
 9. Once you press the ALIGN button the telescope will automatically slew to a second alignment star. Repeat steps 6 and 7 to complete alignment.

EQ Two-Star Align

The EQ Two-Star Align follows most of the same steps as the Alt-Az Two-Star Align. This alignment method does not require the user to align the altitude index markers or point towards the Meridian, but it does require the user to locate and align the telescope on two bright stars. When selecting alignment stars it is best to choose stars that, a) have a large separation in azimuth and b) both are either positive or negative in declination. Following these two guidelines will result in a more accurate EQ Two-Star alignment.

EQ One-Star Align

EQ One-Star Align operates much the same way as EQ Two-Star Align however it only relies on the alignment of one star to align the telescope. To use EQ One-Star Align follow steps 1 through 7 under the EQ Two-Star Align section.

EQ Solar System Align

This alignment method allows you use only one solar system object to equatorially align the telescope for daytime use. To align your telescope using a solar system object follow steps 1 through 7 under the EQ Two-Star Align section.

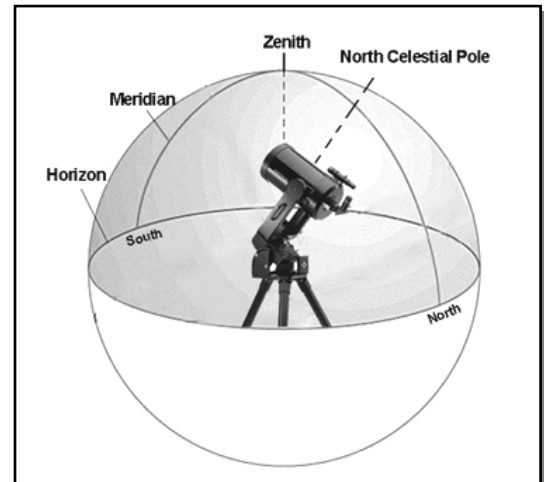

Figure 4-3

The Meridian is an imaginary line in the sky that starts at the North celestial pole and ends at the South celestial pole and passes through the zenith. If you are facing South, the meridian starts from your Southern horizon and passes directly overhead to the North celestial pole.

Improving Pointing Accuracy

The NexStar SE telescope have several options that allow you to improve the pointing accuracy of your mount in a variety of ways.

Alignment Stars:

Alignment stars allows you to replace any of the original alignment stars with a new star or celestial object. This will improve the pointing accuracy of your telescope without having to re-enter addition information.

To replace an existing alignment star with a new alignment star:

1. Select the desired star (or object) from the database and slew to it.
2. Once centered, press the UNDO button until you are at the main menu.
3. With NexStar SE displayed, press the ALIGN key on the hand control.
4. Use the Up/Down buttons and select the *Alignment Stars* option and press ENTER.
5. The display will then ask you which alignment star you want to replace. Use the UP and Down scroll keys to select the alignment star to be replaced and press ENTER. It is usually best to replace the star closest to the new object. This will space out your alignment stars across the sky.
6. Align the star in the center of the finderscope and press ENTER.
7. Carefully center the object in the center of the eyepiece and press ALIGN

Sync:

The Sync feature can be used to improve pointing accuracy in a specific region of the sky. Sync is a very useful feature especially when used in conjunction with the Constellation tour and Identify feature in which you will be exploring smaller areas of the sky. To Sync on an object:

1. Select the desired star (or object) from the database and slew to it.
2. Once centered, press the UNDO button until you are at the main menu.
3. With **NexStar SE** displayed, press the ALIGN key on the hand control.
4. Use the Up/Down buttons and select the Sync option and press ENTER.
5. Align the Sync object in the center of the finderscope and press ENTER.
6. Carefully center the object in the center of the eyepiece and press ALIGN.

Your telescope's pointing accuracy will now be improved in that area of the sky.

NOTE: *Sync* can improve your telescope's pointing accuracy over a wide area or over smaller areas of the sky depending on the quality of the initial alignment, as well as where the telescope was pointing when the *Sync* was done.

Undo Sync:

Since doing a Sync can affect your pointing accuracy in other parts of the sky, it may be necessary to 'Un-Sync' your telescope when exploring other parts of the sky. Doing an Undo Sync will restore the pointing of your telescope to its original alignment. Additionally, if you wish to add calibration stars or re-alignment stars you will be asked to do an Undo Sync before you will be able to proceed

Object Catalog

Selecting an Object

Now that the telescope is properly aligned, you can choose an object from any of the catalogs in the NexStar's database. The hand control has a key designated for each of the catalogs in its database. There are two ways to select objects from the database; scrolling through the named object lists and entering object numbers:

- Pressing the LIST key on the hand control will access all objects in the database that have common names or types. Each list is broken down into the following categories: Named Stars, Named Object, Double Stars, Variable Stars and Asterisms. Selecting any one of these options will display an alpha-numeric listing of the objects under that list. Pressing the Up and Down keys (10) allows you to scroll through the catalog to the desired object.
- Pressing any of the catalog keys (M, CALD, NGC, or STAR) will display a blinking cursor below the name of the catalog chosen. Use the numeric key pad to enter the number of any object within these standardized catalogs. For example, to find the Orion Nebula, press the "M" key and enter "042".
- Pressing the PLANET button will allow you to use the UP and DOWN arrow keys to scroll through and select the eight planets as well as the moon.

When scrolling through a long list of objects, holding down either the Up or Down key will allow you to scroll through the catalog at a rapid speed.

When entering the number for a SAO star, you are only required to enter the first four digits of the objects six digit SAO number. Once the first four digits are entered, the hand control will automatically list all the available SAO objects beginning with those numbers. This allows you to scroll through only the SAO stars in the database. For example, in searching for the SAO star 40186 (Capella), the first four digits would be "0401". Entering this number will display the closest match from the SAO stars available in the database. From there you can scroll down the list and select the desired object.

Slewing to an Object

Once the desired object is displayed on the hand control screen, you have two options:

- **Press the INFO Key.** This will give you useful information about the selected object such as magnitude, constellation and fascinating facts about many of the objects.
- **Press the ENTER Key.** This will automatically slew the telescope to the coordinates of the object. While the telescope is slewing to the object, the user can still access many of the hand control functions (such as displaying information about the object).

If you slew to an object that is below the horizon, NexStar will notify you by displaying a message reminding you that you have selected an object outside of your slew limits (see Slew Limits in the Scope Setup section of the manual). Press UNDO to go back and select a new object. Press ENTER to ignore the message and continue the slew. The NexStar hand control will only display objects that are below the horizon if the Filter Limits are set below 0° in altitude. See Filter Limits in the Utility Feature section of the manual for more information on setting the filter limits.

Caution: Never slew the telescope when someone is looking into the eyepiece. The telescope can move at fast slew speeds and may hit an observer in the eye.

Object information can be obtained without having to do a star alignment. After the telescope is powered on, pressing any of the catalog keys allows you to scroll through object lists or enter catalog numbers and view the information about the object as described above.

Finding Planets

The NexStar can locate all 8 of our solar systems planets plus the Sun and Moon. However, the hand control will only display the solar system objects that are above the horizon (or within its filter limits). To locate the planets, press the PLANET key on the hand control. The hand control will display all solar system objects that are above the horizon:

- Use the **Up and Down** keys to select the planet that you wish to observe.
- Press **INFO** to access information on the displayed planet.
- Press **ENTER** to slew to the displayed planet.

To allow the Sun to be displayed as an option in the database, see *Sun Menu* in the Utilities section of the manual.

Tour Mode

The NexStar includes a tour feature which automatically allows the user to choose from a list of interesting objects based on the date and time in which you are observing. The automatic tour will display only those objects that are within your set filter limits. To activate the Tour mode, press the TOUR key on the hand control. The NexStar will display the best objects to observe that are currently in the sky.

- To see information and data about the displayed object, press the INFO key.
- To slew to the object displayed, press ENTER.
- To see the next tour object, press the Down key.

Constellation Tour

In addition to the Tour Mode, the NexStar telescope has a Constellation Tour that allows the user to take a tour of all the best objects within a particular constellation. Selecting *Constellation* from the LIST menu will display all the constellation names that are above the user defined horizon (filter limits). Once a constellation is selected, you can choose from any of the database object catalogs to produce a list of all the available objects in that constellation.

- To see information and data about the displayed object, press the INFO key.
- To slew to the object displayed, press ENTER.
- To see the next tour object, press the Up key.

Direction Buttons

The NexStar has four direction buttons in the center of the hand control which control the telescope motion in altitude (up and down) and azimuth (left and right). The telescope can be controlled at nine different speed rates.

<i>1 = .5x</i>	<i>6 = 64x</i>
<i>2 = 1x</i>	<i>7 = 1°/sec</i>
<i>3 = 4x</i>	<i>8 = 2°/sec</i>
<i>4 = 8x</i>	<i>9 = 4°/sec</i>
<i>5 = 16x</i>	
Nine available slew speeds	

Rate Button

Pressing the RATE key (11) allows you to instantly change the speed rate of the motors from high speed slew rate to precise guiding rate or anywhere in between. Each rate corresponds to a number on the hand controller key pad. The number 9 is the fastest rate (4° per second, depending on power source) and is used for slewing between objects and locating alignment stars. The number 1 on the hand control is the slowest rate (.5x sidereal) and can be used for accurate centering of objects in the eyepiece. To change the speed rate of the motors:

- Press the RATE key on the hand control. The LCD will display the current speed rate.
- Press the number on the hand control that corresponds to the desired speed.

The hand control has a "double button" feature that allows you to instantly speed up the motors without having to choose a speed rate. To use this feature, simply press the arrow button that corresponds to the direction that you want to move the telescope. While holding that button down, press the opposite directional button. This will increase the speed to the maximum slew rate.

Setup Procedures

The NexStar contains many user defined setup functions designed to give the user control over the telescope's many advanced features. All of the setup and utility features can be accessed by pressing the MENU key and scrolling through the options:

Tracking Mode - Once the NexStar is aligned the tracking motors will automatically turn on and begin tracking the sky. However, the tracking can be turned off for terrestrial use:

Alt-Az	This is the default tracking rate and is used when the telescope is placed on a flat surface or tripod without the use of an equatorial wedge. The telescope must be aligned with two stars before it can track in Alt-Az.
EQ North	Used to track the sky when the telescope is polar aligned using an equatorial wedge in the Northern Hemisphere.
EQ South	Used to track the sky when the telescope is polar aligned using an equatorial wedge in the Southern Hemisphere.
Off	When using the telescope for terrestrial (land) observation, the tracking can be turned off so that the telescope never moves.

Tracking Rate - In addition to being able to move the telescope with the hand control buttons, the NexStar will continually track a celestial object as it moves across the night sky. The tracking rate can be changed depending on what type of object is being observed:

Sidereal This rate compensates for the rotation of the earth by moving the telescope at the same rate as the rotation of the earth, but in the opposite direction. When the telescope is polar aligned, this can be accomplished by moving the telescope in Right Ascension only. When mounted in Alt-Az mode, the telescope must make corrections in both R.A. and declination.

Lunar Used for tracking the moon when observing the lunar landscape.

Solar Used for tracking the Sun when solar observing using a proper solar filter.

View Time-Site - *View Time-Site* will display the last saved time and longitude/latitude entered in the hand control.

User Defined Objects - The NexStar can store over 100 different user defined objects in its memory. The objects can be daytime land objects or an interesting celestial object that you discover that is not included in the regular database. There are several ways to save an object to memory depending on what type of object it is:

Save Sky Object: The NexStar stores celestial objects to its database by saving its right ascension and declination in the sky. This way the same object can be found each time the telescope is aligned. Once a desired object is centered in the eyepiece, simply scroll to the "**Save Sky Obj**" command and press ENTER. The display will ask you to enter a number between 1-99 to identify the object. Press ENTER again to save this object to the database.

Save Database (Db) Object:

This feature allows you to create your own custom tour of database objects by allowing you to record the current position of the telescope and save the name of the object by selecting it from any one of the database catalogs. These objects then can be accessed by selecting *GoTo Sky Object*.

Save Land Object: The NexStar can also be used as a spotting scope on terrestrial objects. Fixed land objects can be stored by saving their altitude and azimuth relative to the location of the telescope at the time of observing. Since these objects are relative to the location of the telescope, they are only valid for that exact location. To save land objects, once again center the desired object in the eyepiece. Scroll down to the "**Save Land Obj**" command and press ENTER. The display will ask you to enter a number between 1-9 to identify the object. Press ENTER again to save this object to the database.

Enter R.A. - Dec: You can also store a specific set of coordinates for an object just by entering the R.A. and declination for that object. Scroll to the "**Enter RA-DEC**" command and press ENTER. The display will then ask you to enter first the R.A. and then the declination of the desired object.

GoTo Object: To go to any of the user defined objects stored in the database, scroll down to either **GoTo Sky Obj** or **GoTo Land Obj** and enter the number of the object you wish to select and press ENTER. NexStar will automatically retrieve and display the coordinates before slewing to the object.

To replace the contents of any of the user defined objects, simply save a new object using one of the existing identification numbers; NexStar will replace the previous user defined object with the current one.

Camera –

Your NexStar mount includes a Camera control feature that allows you to remotely take a series of exposures using your digital SLR (DSLR) camera body. The camera feature comes with an easy to use Camera Wizard that allows you to save a list of as many as nine targets. Then with a DSLR attached or piggyback mounted to your telescope, NexStar will automatically slew to the specified targets and take an exposure of each one.

Connecting a Camera to the NexStar Mount

Your NexStar mount has a camera control port that allows you to connect your camera using the supplied Shutter Release Cable and a firing cable for your model of camera (not included). To connect you camera:

1. Attach the phone jack end of the supplied cable into the camera port on the base of the mount.
2. Plug the 2.5mm mono jack end of your user supplied firing cable into the Shutter Release Cable.
3. Plug the firing cable into the electric cable release port for your model of camera.

For a description of how to attach a camera body to you NexStar mount, see *Astronomy Basics* section.

To locate a firing cable for your model of camera, contact your local camera retailer or go to the following web site, <http://www.microsyncdigital.com>

Controlling your Camera

Camera Wizard

The Camera Wizard is the quickest way to build an imaging sequence of targets and exposure times. The Wizard will ask you to point the telescope/camera to up to 9 objects. After the user selects 9 objects or presses UNDO it asks you whether the sequence should repeat forever (perhaps for security monitoring) or whether it should stop when it gets to the end.

To use the Camera Wizard:

1. From the Main Menu, press the Menu button and select the Camera option
2. Select the Camera Wizard option and press Enter
3. The hand control will prompt you to slew the telescope to the objects you wish to photograph. Carefully center the object in the eyepiece or camera viewfinder.
4. Repeat step #3 for as many as nine different objects or press Undo after the last selected object has been centered.
5. Next use the Up/Down buttons to select whether you want the imaging sequence to stop after the final target has been photographed or if you want it to start over from the beginning and repeat the exposure sequence.
6. Press Enter if you wish to start the exposure sequence as is, or press Undo if you wish to edit the individual object entries.

Take Exposure - The Take Exposures option starts the imaging sequence. You can hit UNDO at any time to abort the sequence.

Edit Entries – Edit Entries can be used to view, edit or add objects to the list that was created with the Camera Wizard. You can scroll through each object in the list and select the parameters you want to edit.

Each list entry has the following attributes:

Object Type:

Sky Object - Saves the object as a user defined sky object

- Land Object – Saves the object as a user defined land object
- Note: If the telescope was aligned when the object list was created, then the Camera Wizard will automatically save new objects as sky object. If the telescope is not aligned, objects are saved as land objects.
- No Change -The No Change object type is used when you want to take an image of the same object that was selected before it, but with a different exposure time. This prevents the telescope from re-slewing to the same object when only the exposure values have been changed.
- Empty – This indicates that there is no object saved for that entry. If the object type is changed to “empty”, the information for that entry will be erased.

Object Number (for land and sky objects) - Although the Camera Wizard only lets you save up to nine objects, there are 25 allotted spaces that allow you to add additional entries of your own. For example, if you already have user defined objects stored to memory, you can select the number of the object and its position will also be saved to your imaging sequence.

Repeat Count- Allows you to set the number of exposures per object.

Exposure Time- Allows you to set the duration of each exposure in seconds.

Long exposures – To take an exposure for more than 1 second, your camera must be set to the “Bulb” setting. Then the camera will take the exposure for the amount of time entered into the hand control.

Snapshots- If you want to take an image for 1 second or less, your camera should in normal mode and the hand control exposure value should be set to “1”. When this value is set to “1”, the camera will default back to “snapshot” mode and will take an exposure for the duration of time determined by your camera.

Exposure Delay- Allows you to set a time delay between each exposure.

Sequence End - The Sequence End option lets you select whether the imaging sequence should repeat indefinitely or stop once it reaches the last entry.

Get RA/DEC - Displays the right ascension and declination for the current position of the telescope.

Goto R.A/ Dec - Allows you to input a specific R.A. and declination and slew to it.

Identify

Identify Mode will search any of the NexStar database catalogs or lists and display the name and offset distances to the nearest matching objects. This feature can serve two purposes. First, it can be used to identify an unknown object in the field of view of your eyepiece. Additionally, *Identify Mode* can be used to find other celestial objects that are close to the objects you are currently observing. For example, if your telescope is pointed at the brightest star in the constellation Lyra, choosing *Identify* and then searching the *Named Star* catalog will no doubt return the star Vega as the star you are observing. However, by selecting *Identify* and searching by the *Named Object* or *Messier* catalogs, the hand control will let you know that the Ring Nebula (M57) is approximately 6° from your current position. Searching the Double Star catalog will reveal that Epsilon Lyrae is only 1° away from Vega. To use the *Identify* feature:

- Press the Menu button and select the Identify option.
- Use the Up/Down scroll keys to select the catalog that you would like to search.
- Press ENTER to begin the search.

Note: Some of the databases contain thousands of objects, and can therefore take a minute or two to return the closest object.

Precise GoTo

The NexStar has a precise goto function that can assist in finding extremely faint objects and centering objects closer to the center of the field of view for high power viewing or astrophotography. Precise Goto automatically searches out the closest bright star to the desired object and asks the user to carefully center it in the eyepiece. The hand control then calculates the small difference between its goto position and its centered position. Using this offset, the telescope will then slew to the desired object with enhanced accuracy. To use Precise Goto:

1. Press the MENU button and use the Up/Down keys to select *Precise Goto*.
 - Choose *Database* to select the object that you want to observe from any of the database catalogs listed
 - Choose *RA/DEC* to enter a set of celestial coordinates that you wish to slew to.
2. Once the desired object is selected, the hand control will search out and display the closest bright star to your desired object. Press ENTER to slew to the bright alignment star.
3. Use the direction buttons to carefully center the alignment star in the eyepiece.

Press ENTER to slew to the desired object.

Scope Setup Features

Setup Time-Site - Allows the user to customize the NexStar display by changing time and location parameters (such as time zone and daylight savings).

Anti-backlash - All mechanical gears have a certain amount of backlash or play between the gears. This play is evident by how long it takes for a star to move in the eyepiece when the hand control arrow buttons are pressed (especially when changing directions). The NexStar's anti-backlash features allows the user to compensate for backlash by inputting a value which quickly rewinds the motors just enough to eliminate the play between gears. The amount of compensation needed depends on the slewing rate selected; the slower the slewing rate the longer it will take for the star to appear to move in the eyepiece. Therefore, the anti-backlash compensation will have to be set higher. You will need to experiment with different values; a value between 20 and 50 is usually best for most visual observing, whereas a higher value may be necessary for photographic guiding. Positive backlash compensation is applied when the mount changes its direction of movement from backwards to forwards. Similarly, negative backlash compensation is applied when the mount changes its direction of movement from forwards to backwards. When tracking is enabled, the mount will be moving in one or both axes in either the positive or negative direction, so backlash compensation will always be applied when a direction button is released and the direction moved is opposite to the direction of travel.

To set the anti-backlash value, scroll down to the anti-backlash option and press ENTER. Enter a value from 0-99 for both azimuth and altitude directions and press ENTER after each one to save these values. NexStar will remember these values and use them each time it is turned on until they are changed.

Slew Limits - Sets the limits in altitude that the telescope can slew without displaying a warning message. The slew limits prevent the telescope tube from slewing to an object below the horizon. The slew limits can be customized depending on your needs. For example, if you would like to slew to an object that is close to the zenith but you have a camera attached that prevents it from pointing straight up, you can set the maximum altitude to 80 or 85 degrees to prevent the tube from ever pointing straight up.

Filter Limits - When an alignment is complete, the NexStar automatically knows which celestial objects are above the horizon. As a result, when scrolling through the database lists (or selecting the Tour function), the NexStar hand control will display only those objects that are known to be above the horizon when you are observing. You can customize the object database by selecting altitude limits that are appropriate for your location and situation. For example, if you are observing from a mountainous location where the horizon is partially obscured, you can set your minimum altitude limit to read +20°. This will make sure that the hand control only displays objects that are higher in altitude than 20°.

Observing Tip!

If you want to explore the entire object database, set the maximum altitude limit to 90° and the minimum limit to -90°. This will display every object in the database lists regardless of whether it is visible in the sky from your location or not.

Direction Buttons - The direction a star moves in the eyepiece varies depending on the accessories being used. This can create confusion when guiding on a star using an off-axis guider versus a straight through guide scope. To compensate for this, the direction of the drive control keys can be changed. To reverse the button logic of the hand control, press the MENU button and select *Direction Buttons* from the Utilities menu. Use the Up/Down arrow keys (10) to select either the Azimuth buttons (left and right) or Altitude buttons (up and down) and press ENTER. Pressing ENTER again will reverse the direction of the hand control buttons from their current state. Direction Buttons will only change the eyepiece rates (rate 1-6) and will not affect the slew rates (rate 7-9).

Goto Approach - lets the user define the direction that the telescope will approach when slewing to an object. This allows the user the ability to minimize the affects of backlash. For example, if your telescope is back heavy from using heavy optical or photographic accessories attached to the back, you would want to set your altitude approach to the negative direction. This would ensure that the telescope always approaches an object from the opposite direction as the load pulling on the scope. Similarly, if using the telescope

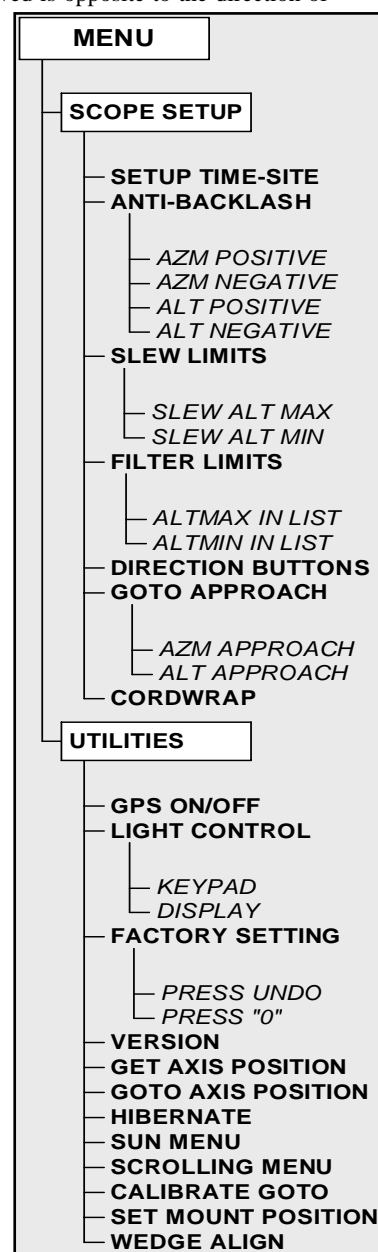

while polar aligned, you would want to set the azimuth approach to the direction that allows the scope to compensate for different load level on the motors and gears when pointing in different parts of the sky.

To change the goto approach direction, simply choose *Goto Approach* from the *Scope Setup* menu, select either Altitude or Azimuth approach, choose positive or negative and press Enter.

Cordwrap - – Cord wrap safeguards against the telescope slewing more than 360° in azimuth and wrapping accessory or power cables around the base of the telescope. This is useful any time that cables are plugged into the base of the telescope. By default, the cord wrap feature is turned off when the telescope is aligned in altazimuth and turn on when aligned on a wedge.

Utility Features

Scrolling through the MENU options will also provide access to several advanced utility functions such as anti-backlash compensation and slew limits.

Wedge Align – The NexStar has two equatorial alignment modes (one for the northern hemisphere and one for the southern) that will help you to polar align your telescope when using an optional equatorial wedge. See the *Astronomy Basics* section of the manual for more information on the *Wedge Align* feature.

GPS On/Off - Allows you to turn on/off the GPS module when using the optional CN16 GPS accessory. When aligning the telescope, the NexStar still receives information, such as current time, from the optional GPS accessory. If you want to use the hand control database to find the coordinates of a celestial object for a future date you would need to turn the GPS module off in order to manually enter a date and time other than the present.

Light Control – This feature allows you to turn off both the red key pad light and LCD display for daytime use to conserve power and to help preserve your night vision.

Factory Setting – Returns the NexStar hand control to its original factory setting. Parameters such as backlash compensation values, initial date and time, longitude/latitude along with slew and filter limits will be reset. However, stored parameters such as user defined objects will remain saved even when *Factory Settings* is selected. The hand control will ask you to press the "0" key before returning to the factory default setting.

Version - Selecting this option will allow you to see the version number of the hand control software.

Get Axis Position - Displays the relative altitude and azimuth for the current position of the telescope.

Goto Axis Position - Allows you to enter a specific altitude and azimuth position and slew to it.

Hibernate - Hibernate allows the NexStar to be completely powered down and still retain its alignment when turned back on. This not only saves power, but is ideal for those that have their telescopes permanently mounted or leave their telescope in one location for long periods of time. To place your telescope in Hibernate mode:

1. Select Hibernate from the Utility Menu.
2. Move the telescope to a desire position and press ENTER.
3. Power off the telescope. Remember to never move your telescope manually while in Hibernate mode.

Once the telescope is powered on again the display will read Wake Up. After pressing Enter you have the option of scrolling through the time/site information to confirm the current setting. Press ENTER to wake up the telescope.

Helpful Hint

Pressing UNDO at the Wake Up screen allows you to explore many of the features of the hand control without waking the telescope up from hibernate mode. To wake up the telescope after UNDO has been pressed, select Hibernate from the Utility menu and press ENTER. Do not use the direction buttons to move the telescope while in hibernate mode.

Sun Menu

For safety purposes the Sun will not be displayed as a database object unless it is first enabled. To enable the Sun, go to the *Sun Menu* and press ENTER. The Sun will now be displayed in the Planets catalog as can be used as an alignment object when using the Solar System Alignment method. To remove the Sun from displaying on the hand control, once again select the Sun Menu from the Utilities Menu and press ENTER.

Scrolling Menu

This menu allows you to change the rate of speed that the text scrolls across the hand control display.

- Press the Up (number 6) button to increase the speed of the text.
- Press the Down (number 9) button to decrease the speed of the text.

Calibrate Goto

Goto Calibration is a useful tool when attaching heavy visual or photographic accessories to the telescope. Goto Calibration calculates the amount of distance and time it takes for the mount to complete its final slow goto when slewing to an object. Changing the balance of the telescope can prolong the time it takes to complete the final slew. Goto Calibration takes into account any slight imbalances and changes the final goto distance to compensate.

Set Mount Position

The Set Mount Position menu can be used to recover an alignment in cases where the telescope or tripod has been manually moved. For instance, you might use this feature if you needed to adjust the level of the tripod by raising or lowering the tripod legs. After the mount has been moved, simply slew to a bright star and center it up in the eyepiece, then select *Set Mount Position* from the Utilities menu. Since the telescope has been moved, the pointing accuracy will be diminished. But now you can slew to a new set of alignment stars and replace any of the original alignment stars with the new stars. This will help you to avoid having to start the alignment process over from the beginning.

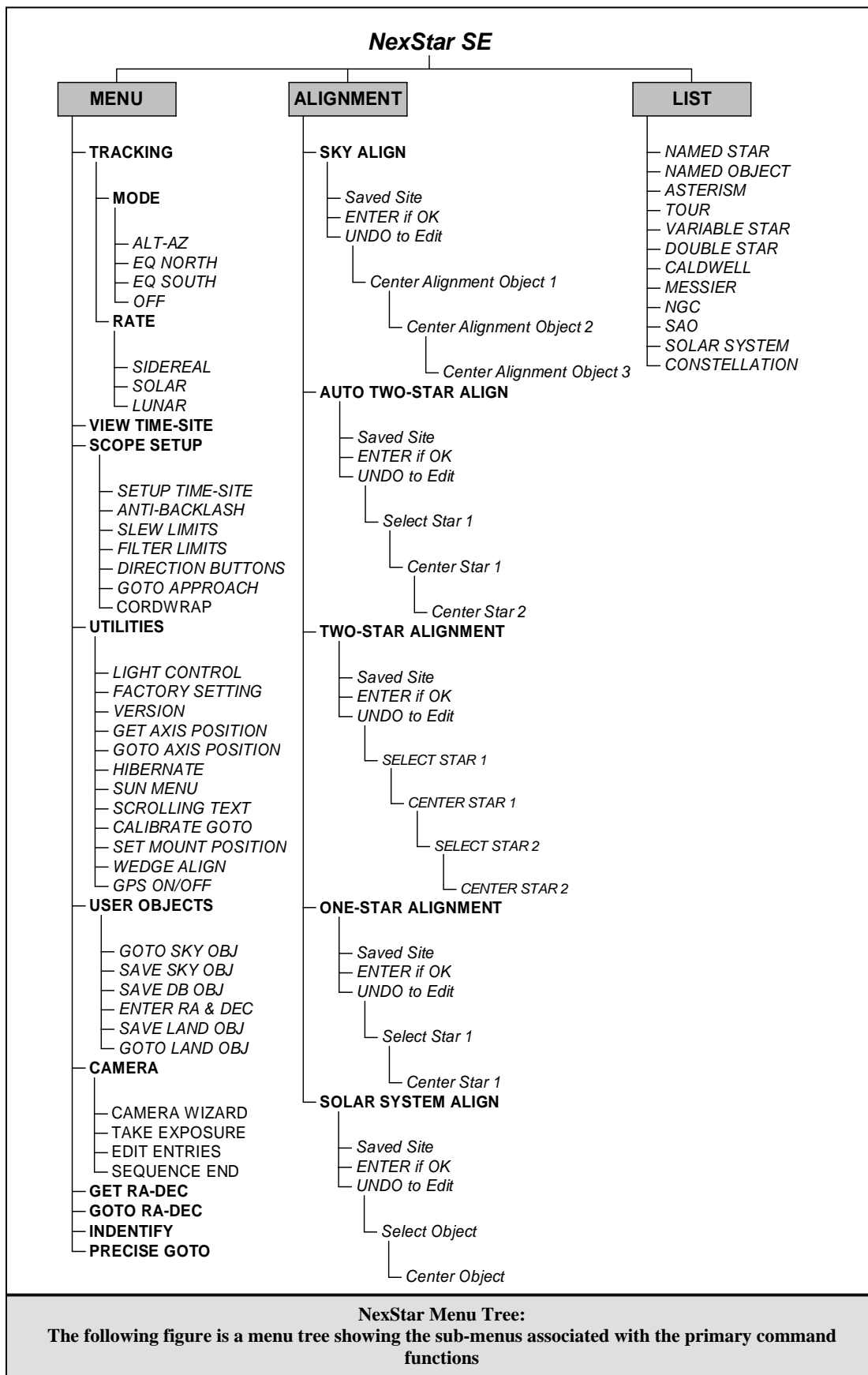

NexStar Menu Tree:
The following figure is a menu tree showing the sub-menus associated with the primary command functions



Telescope Basics

A telescope is an instrument that collects and focuses light. The nature of the optical design determines how the light is focused. Some telescopes, known as refractors, use lenses. Other telescopes, known as reflectors, use mirrors. The Schmidt-Cassegrain optical system (or Schmidt-Cass for short) uses a combination of mirrors and lenses and is referred to as a compound or catadioptric telescope. This unique design offers large-diameter optics while maintaining very short tube lengths, making them extremely portable. The Schmidt-Cassegrain system consists of a zero power corrector plate, a spherical primary mirror, and a secondary mirror. Once light rays enter the optical system, they travel the length of the optical tube three times.

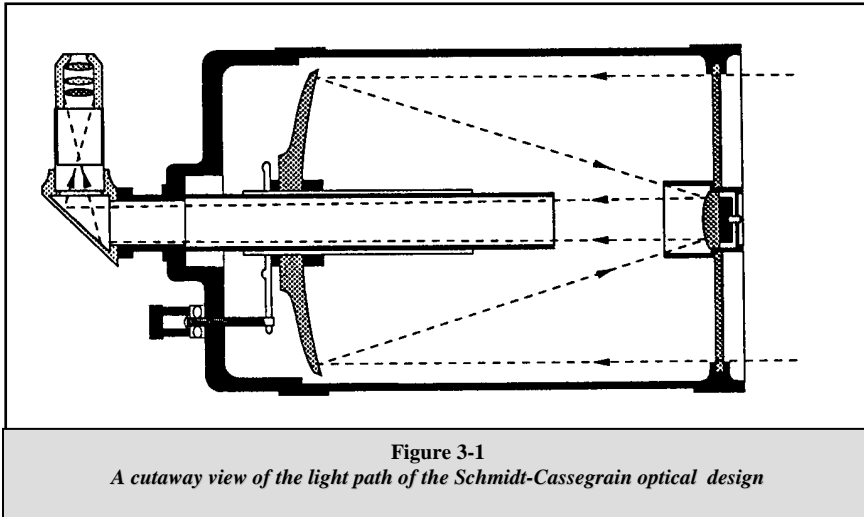

Figure 3-1
A cutaway view of the light path of the Schmidt-Cassegrain optical design

The optics of the NexStar have Starbright XLT coatings - enhanced multi-layer coatings on the primary and secondary mirrors for increased reflectivity and a fully coated corrector for the finest anti-reflection characteristics.

Inside the optical tube, a black tube extends out from the center hole in the primary mirror. This is the primary baffle tube and it prevents stray light from passing through to the eyepiece or camera.

Image Orientation

The image orientation changes depending on how the eyepiece is inserted into the telescope. When using the star diagonal, the image is right-side-up, but reversed from left-to-right (i.e., reverted). If inserting the eyepiece directly into the visual back (i.e., without the star diagonal), the image is upside-down and reversed from left-to-right (i.e., inverted). This is normal for the Schmidt-Cassegrain design.



Actual image orientation as seen with the unaided eye



Reversed from left to right, as viewed with a Star Diagonal

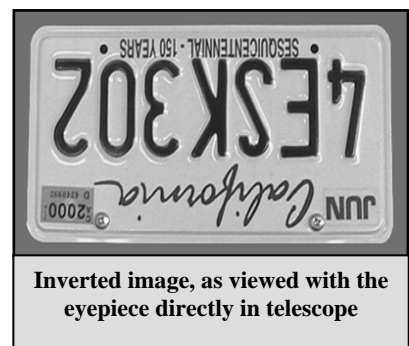

Inverted image, as viewed with the eyepiece directly in telescope

Figure 3-2

Focusing

The NexStar's focusing mechanism controls the primary mirror which is mounted on a ring that slides back and forth on the primary baffle tube. The focusing knob, which moves the primary mirror, is on the rear cell of the telescope just below the star diagonal and eyepiece. Turn the focusing knob until the image is sharp. If the knob will not turn, it has reached the end of its travel on the focusing mechanism. Turn the knob in the opposite direction until the image is sharp. Once an image is in focus, turn the knob clockwise to focus on a closer object and counterclockwise for a more distant object. A single turn of the focusing knob moves the primary mirror only slightly. Therefore, it will take many turns (about 30) to go from close focus (approximately 25 feet) to infinity.

For astronomical viewing, out of focus star images are very diffuse, making them difficult to see. If you turn the focus knob too quickly, you can go right through focus without seeing the image. To avoid this problem, your first astronomical target should be a bright object (like the Moon or a planet) so that the image is visible even when out of focus. Critical focusing is best accomplished when the focusing knob is turned in such a manner that the mirror moves against the pull of gravity. In doing so, any mirror shift is minimized. For astronomical observing, both visually and photographically, this is done by turning the focus knob counterclockwise.

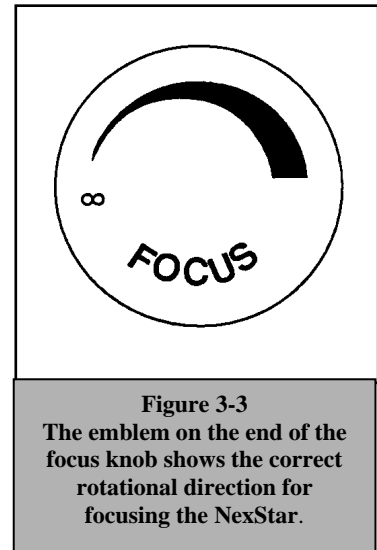

Calculating Magnification

You can change the power of your telescope just by changing the eyepiece (ocular). To determine the magnification of your telescope, simply divide the focal length of the telescope by the focal length of the eyepiece used. In equation format, the formula looks like this:

$$\text{Magnification} = \frac{\text{Focal Length of Telescope (mm)}}{\text{Focal Length of Eyepiece (mm)}}$$

Let's say, for example, you are using the 25mm eyepiece. To determine the magnification you simply divide the focal length of your telescope (the NexStar 5 has a focal length of 1250mm) by the focal length of the eyepiece, 25mm. Dividing 1250 by 25 yields a magnification of 50 power.

Although the power is variable, each instrument under average skies has a limit to the highest useful magnification. The general rule is that 60 power can be used for every inch of aperture. For example, the NexStar 5 is 5" in diameter. Multiplying 5 by 60 gives a maximum useful magnification of 300 power. Although this is the maximum useful magnification, most observing is done in the range of 20 to 35 power for every inch of aperture which is 100 to 175 times for the NexStar telescope.

Determining Field of View

Determining the field of view is important if you want to get an idea of the angular size of the object you are observing. To calculate the actual field of view, divide the apparent field of the eyepiece (supplied by the eyepiece manufacturer) by the magnification. In equation format, the formula looks like this:

$$\text{True Field} = \frac{\text{Apparent Field of Eyepiece}}{\text{Magnification}}$$

As you can see, before determining the field of view, you must calculate the magnification. Using the example in the previous section, we can determine the field of view using the same 25mm eyepiece. The 25mm eyepiece has an apparent field of view of 52°. Divide the 52° by the magnification, which is 50 power. This yields an actual field of view of slightly less than 1°.

To convert degrees to feet at 1,000 yards, which is more useful for terrestrial observing, simply multiply by 52.5. Continuing with our example, multiply the angular field 1.° by 52.5. This produces a linear field width of 52.5 feet at a distance of one

thousand yards. The apparent field of each eyepiece that Celestron manufactures is found in the Celestron Accessory Catalog (#93685).

General Observing Hints

When working with any optical instrument, there are a few things to remember to ensure you get the best possible image.

- Never look through window glass. Glass found in household windows is optically imperfect, and as a result, may vary in thickness from one part of a window to the next. This inconsistency can and will affect the ability to focus your telescope. In most cases you will not be able to achieve a truly sharp image, while in some cases, you may actually see a double image.
- Never look across or over objects that are producing heat waves. This includes asphalt parking lots on hot summer days or building rooftops.
- Hazy skies, fog, and mist can also make it difficult to focus when viewing terrestrially. The amount of detail seen under these conditions is greatly reduced. Also, when photographing under these conditions, the processed film may come out a little grainier than normal with lower contrast and underexposed.
- If you wear corrective lenses (specifically glasses), you may want to remove them when observing with an eyepiece attached to the telescope. When using a camera, however, you should always wear corrective lenses to ensure the sharpest possible focus. If you have astigmatism, corrective lenses must be worn at all times.

Astronomy Basics

Up to this point, this manual covered the assembly and basic operation of your NexStar telescope. However, to understand your telescope more thoroughly, you need to know a little about the night sky. This section deals with observational astronomy in general and includes information on the night sky and polar alignment.

The Celestial Coordinate System

To help find objects in the sky, astronomers use a celestial coordinate system that is similar to our geographical coordinate system here on Earth. The celestial coordinate system has poles, lines of longitude and latitude, and an equator. For the most part, these remain fixed against the background stars.

The celestial equator runs 360 degrees around the Earth and separates the northern celestial hemisphere from the southern. Like the Earth's equator, it bears a reading of zero degrees. On Earth this would be latitude. However, in the sky this is referred to as declination, or DEC for short. Lines of declination are named for their angular distance above and below the celestial equator. The lines are broken down into degrees, minutes of arc, and seconds of arc. Declination readings south of the equator carry a minus sign (-) in front of the coordinate and those north of the celestial equator are either blank (i.e., no designation) or preceded by a plus sign (+).

The celestial equivalent of longitude is called Right Ascension, or R.A. for short. Like the Earth's lines of longitude, they run from pole to pole and are evenly spaced 15 degrees apart. Although the longitude lines are separated by an angular distance, they are also a measure of time. Each line of longitude is one hour apart from the next. Since the Earth rotates once every 24 hours, there are 24 lines total. As a result, the R.A. coordinates are marked off in units of time. It begins with an arbitrary point in the constellation of Pisces designated as 0 hours, 0 minutes, 0 seconds. All other points are designated by how far (i.e., how long) they lag behind this coordinate after it passes overhead moving toward the west.

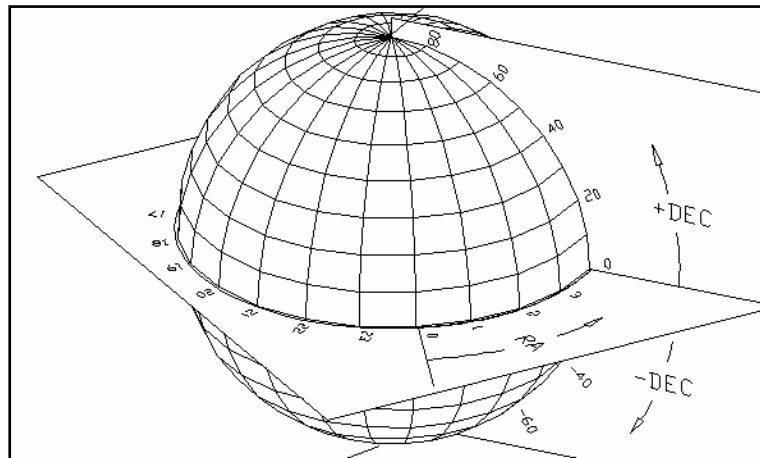
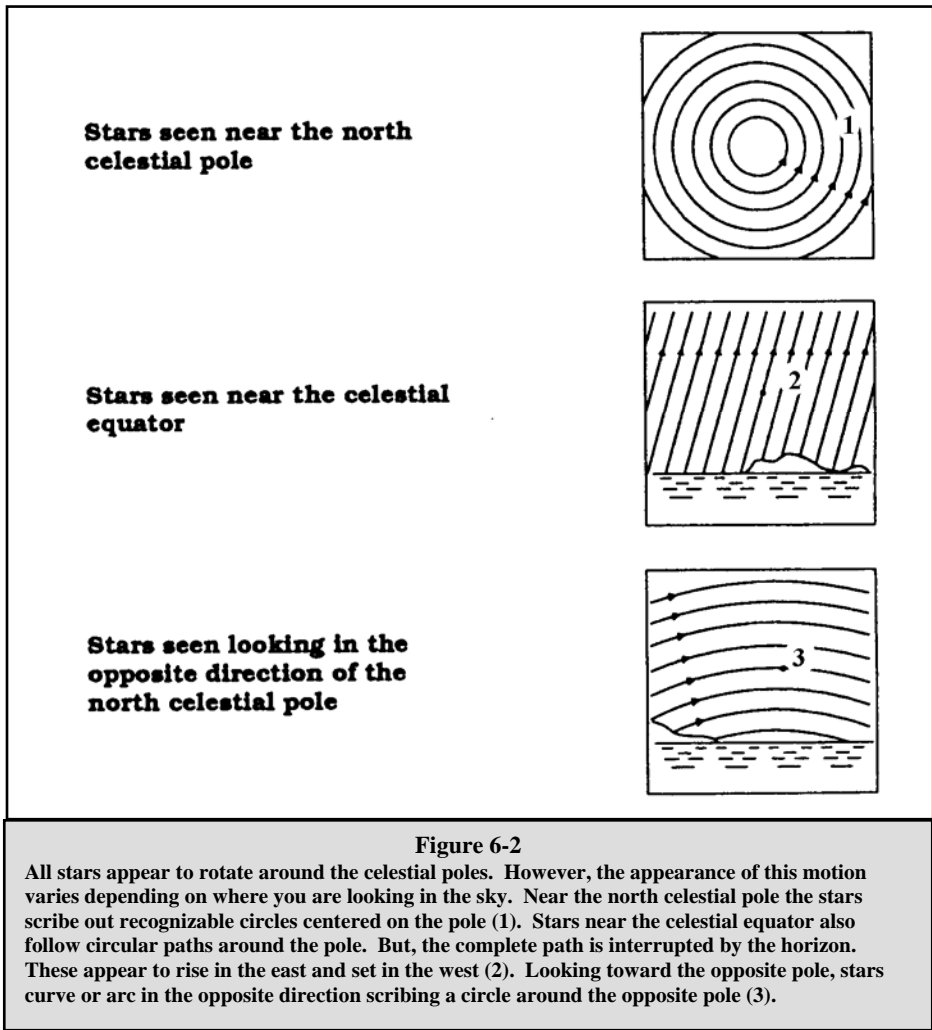

Figure 6-1
The celestial sphere seen from the outside showing R.A. and DEC.

Motion of the Stars

The daily motion of the Sun across the sky is familiar to even the most casual observer. This daily trek is not the Sun moving as early astronomers thought, but the result of the Earth's rotation. The Earth's rotation also causes the stars to do the same, scribing out a large circle as the Earth completes one rotation. The size of the circular path a star follows depends on where it is in the sky. Stars near the celestial equator form the largest circles rising in the east and setting in the west. Moving toward the north celestial pole, the point around which the stars in the northern hemisphere appear to rotate, these circles become smaller. Stars in the mid-celestial latitudes rise in the northeast and set in the northwest. Stars at high celestial latitudes are always above the horizon, and are said to be circumpolar because they never rise and never set. You will never see the stars complete one circle because the sunlight during the day washes out the starlight. However, part of this circular motion of stars in this region of the sky can be seen by setting up a camera on a tripod and opening the shutter for a couple hours. The processed film will reveal semicircles that revolve around the pole. (This description of stellar motions also applies to the southern hemisphere except all stars south of the celestial equator move around the south celestial pole.)



Polar Alignment

Even though the NexStar can precisely track a celestial object while in the Alt-Az position, it is still necessary to align the polar axis of the telescope (the fork arm) to the Earth's axis on rotation in order to attempt long exposure astro photography. This is accomplished by using the built-in wedge attached to the steel tripod. This allows the telescope's tracking motors to rotate the telescope around the celestial pole, the same way as the stars. Without the equatorial wedge, you would notice the stars in the eyepiece would slowly rotate around the center of the field of view. Although this gradual rotation would go unnoticed when viewing with an eyepiece, it would be very noticeable on film.

Polar alignment is the process by which the telescope's axis of rotation (called the polar axis) is aligned (made parallel) with the Earth's axis of rotation. Once aligned, a telescope with a clock drive will track the stars as they move across the sky. The result is that objects observed through the telescope appear stationary (i.e., they will not drift out of the field of view). If not using the clock drive, all objects in the sky (day or night) will slowly drift out of the field. This motion is caused by the Earth's rotation.

The polar axis is the axis around which the telescope rotates when moved in right ascension. This axis points the same direction even when the telescope moves in right ascension and declination.

Definition

Aligning the NexStar on a Wedge

The simplest way to get a basic polar alignment with your NexStar is to angle the tilt plate on top of the tripod so that the fork arm (or polar axis) is pointed towards the star Polaris. For help in locating Polaris, refer to the Finding the North Celestial Pole section below. To polar align your NexStar:

1. Position the telescope tripod so that tilt plate hinge is facing towards north.
2. Gently rotate the telescope tube so that it is pointing straight up in the sky.
3. Loosen the Latitude Adjustment Lock on the tripod.
4. Slowly tilt the telescope towards the north until the scale on the Latitude Adjustment Rod is equal to the latitude of your observing location. For example, if using your telescope from Los Angeles, you would set the scale to 34 degrees.

Note: To view your current latitude, select View Time-Site menu feature after completing a successful alignment.

5. Once in position, securely tighten the latitude adjustment lock to hold the telescope in place.

You are now ready to complete an *EQ North (South) Alignment* to begin finding celestial objects and a *Wedge Align* for a more accurate polar alignment.

Wedge Align

The NexStar has two equatorial wedge alignment modes (one for the northern hemisphere and one for the southern) that will help you polar align your telescope when using an equatorial wedge. After performing either an EQ AutoAlign or Two-Star Alignment, Wedge Align will slew the telescope to where Polaris should be. By adjusting the tripod's tilt plate to center Polaris in the eyepiece, the fork arm (polar axis) will then be pointing towards the actual North Celestial Pole. Once Wedge Align is complete, you must re-align your telescope using any of the EQ alignment methods. Follow these steps to Wedge Align your telescope in the Northern Hemisphere:

1. With the NexStar set up as described in the section above and roughly positioned towards Polaris, align the telescope using either the EQ AutoAlign or Two-Star Alignment method.
2. Select *Wedge Align* from the Utilities menu and press Enter.

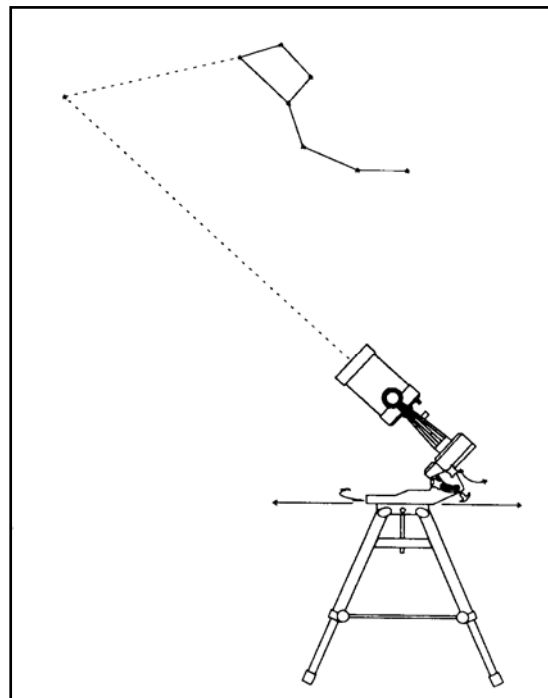

Figure 6-3

This is how the telescope is to be set up for polar alignment. The tube should be parallel to the fork arm which should be pointed to Polaris.

Based on your current alignment, NexStar will slew to where it thinks Polaris should be. Use the tripod's tilt plate adjustment to place Polaris in the center of the eyepiece. Do not use the hand control's direction buttons to position Polaris. Once Polaris is centered in the eyepiece, press ENTER; the polar axis should then be pointed towards the North Celestial Pole.

Photography with the NexStar

After looking at the night sky for a while you may want to try photographing it. In addition to the specific accessories required for celestial photography, there is the need for a camera - but not just any camera. The camera does not have to have many of the features offered on today's state-of-the-art equipment. For example, you don't need auto focus capability or mirror lock up. Here are the mandatory features a camera needs for celestial photography. First, a "B" setting which allows for time exposures. This excludes point and shoot cameras and limits the selection to SLR cameras, the most common type of 35mm camera on the market today.

Second, the "B" or manual setting should NOT run off the battery. Many new electronic cameras use the battery to keep the shutter open during time exposures. Once the batteries are drained, usually after a few minutes, the shutter closes, whether you were finished with the exposure or not. Look for a camera that has a manual shutter when operating in the time exposure mode. Olympus, Nikon, Minolta, Pentax, Canon and others have made such camera bodies.

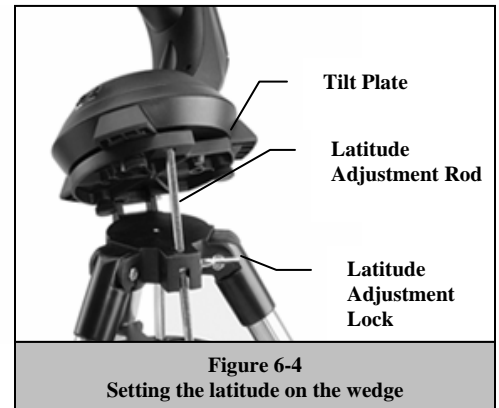

Figure 6-4
Setting the latitude on the wedge

The camera must have interchangeable lenses so you can attach it to the telescope and so you can use a variety of lenses for piggyback photography. If you can't find a new camera, you can purchase a used camera body that is not 100-percent functional. The light meter, for example, does not have to be operational since you will be determining the exposure length manually.

You also need a cable release with a locking function to hold the shutter open while you do other things. Mechanical and air release models are available.

Attaching a Camera to the NexStar

Attaching a camera to the NexStar requires the use of the optional T-adapter (#93633-A) and a T-ring specific to the brand of camera being used. See *Optional Accessories* section in this manual. To attach the photographic accessories:

1. Remove the visual back from the rear cell .
2. Thread the T-adapter securely onto the rear cell of the telescope.
3. Thread the T-ring onto the exposed end of the T-adapter.
4. Remove any lens from the body of your camera.
5. Attach the camera body to the T-ring by aligning the dot on the side of the T-ring with the dot on the camera body and twisting.

Finding the North Celestial Pole

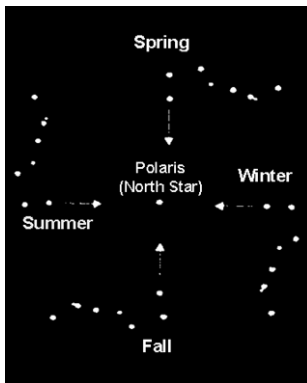

Figure 6-5
The position of the Big Dipper changes throughout the year and the night.

In each hemisphere, there is a point in the sky around which all the other stars appear to rotate. These points are called the celestial poles and are named for the hemisphere in which they reside. For example, in the northern hemisphere all stars move around the north celestial pole. When the telescope's polar axis is pointed at the celestial pole, it is parallel to the Earth's rotational axis.

Many methods of polar alignment require that you know how to find the celestial pole by identifying stars in the area. For those in the northern hemisphere, finding the celestial pole is not too difficult. Fortunately, we have a naked eye star less than a degree away. This star, Polaris, is the end star in the handle of the Little Dipper. Since the Little Dipper (technically called Ursa Minor) is not one of the brightest constellations in the sky, it may be difficult to locate from urban areas. If this is the case, use the two end stars in the bowl of the Big Dipper (the pointer stars). Draw an imaginary line through them toward the Little Dipper. They point to Polaris (see Figure 6-5). The position of the Big Dipper changes during the year and throughout the course of the night (see Figure 6-5). When the Big Dipper is low in the sky (i.e., near the horizon), it may be difficult to locate. During these times, look for Cassiopeia (see Figure 6-6). Observers in the southern hemisphere are not as fortunate as those in the northern hemisphere. The stars around the south celestial pole are not nearly as bright as those around the north. The closest star that is relatively bright is Sigma Octantis. This star is just within naked eye limit

(magnitude 5.5) and lies about 59 arc minutes from the pole.

Definition

The north celestial pole is the point in the northern hemisphere around which all stars appear to rotate. The counterpart in the southern hemisphere is referred to as the south celestial pole.

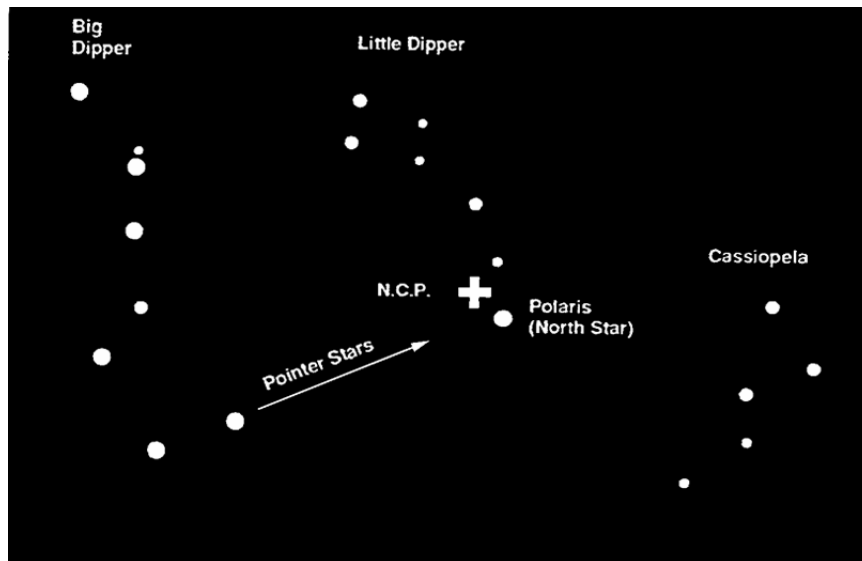

Figure 6-6
The two stars in the front of the bowl of the Big Dipper point to Polaris which is less than one degree from the true (north) celestial pole. Cassiopeia, the "W" shaped constellation, is on the opposite side of the pole from the Big Dipper. The North Celestial Pole (N.C.P.) is marked by the "+" sign.

Celestial Observing

With your telescope set up, you are ready to use it for observing. This section covers visual observing hints for both solar system and deep sky objects as well as general observing conditions which will affect your ability to observe.

Observing the Moon

Often, it is tempting to look at the Moon when it is full. At this time, the face we see is fully illuminated and its light can be overpowering. In addition, little or no contrast can be seen during this phase.

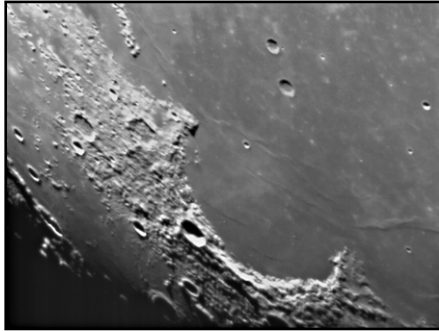

One of the best times to observe the Moon is during its partial phases (around the time of first or third quarter). Long shadows reveal a great amount of detail on the lunar surface. At low power you will be able to see most of the lunar disk at one time. Change to higher power (magnification) to focus in on a smaller area. Choose the *lunar* tracking rate from the NexStar's MENU tracking rate options to keep the moon centered in the eyepiece even at high magnifications.

Lunar Observing Hints

- To increase contrast and bring out detail on the lunar surface, use filters. A

yellow filter works well at improving contrast while a neutral density or polarizing filter will reduce overall surface brightness and glare.

Observing the Planets

Other fascinating targets include the five naked eye planets. You can see Venus go through its lunar-like phases. Mars can reveal a host of surface detail and one, if not both, of its polar caps. You will be able to see the cloud belts of Jupiter and the great Red Spot (if it is visible at the time you are observing). In addition, you will also be able to see the moons of Jupiter as they orbit the giant planet. Saturn, with its beautiful rings, is easily visible at moderate power.

Planetary Observing Hints

- Remember that atmospheric conditions are usually the limiting factor on how much planetary detail will be visible. So, avoid observing the planets when they are low on the horizon or when they are directly over a source of radiating heat, such as a rooftop or chimney. See the "*Seeing Conditions*" section later in this section.
- To increase contrast and bring out detail on the planetary surface, try using Celestron eyepiece filters.

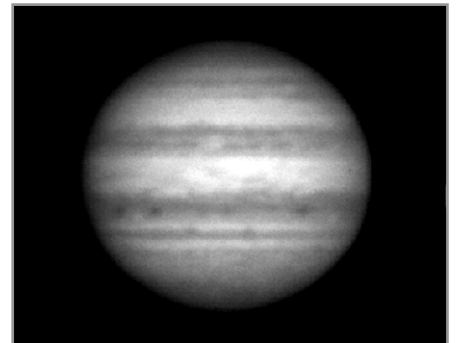

Observing the Sun

Although overlooked by many amateur astronomers, solar observation is both rewarding and fun. However, because the Sun is so bright, special precautions must be taken when observing our star so as not to damage your eyes or your telescope.

Never project an image of the Sun through the telescope. Because of the folded optical design, tremendous heat build-up will result inside the optical tube. This can damage the telescope and/or any accessories attached to the telescope.

For safe solar viewing, use a Celestron solar filter (see *Optional Accessories* section of manual) that reduces the intensity of the Sun's light, making it safe to view. With a filter you can see sunspots as they move across the solar disk and faculae, which are bright patches seen near the Sun's edge.

Solar Observing Hints

- The best time to observe the Sun is in the early morning or late afternoon when the air is cooler.
- To center the Sun without looking into the eyepiece, watch the shadow of the telescope tube until it forms a circular shadow.
- To ensure accurate tracking, be sure to select solar tracking rate.

Observing Deep Sky Objects

Deep-sky objects are simply those objects outside the boundaries of our solar system. They include star clusters, planetary nebulae, diffuse nebulae, double stars and other galaxies outside our own Milky Way. Most deep-sky objects have a large angular size. Therefore, low-to-moderate power is all you need to see them. Visually, they are too faint to reveal any of the color seen in long exposure photographs. Instead, they appear black and white. And, because of their low surface brightness, they should be observed from a dark-sky location. Light pollution around large urban areas washes out most nebulae making them difficult, if not impossible, to observe. Light Pollution Reduction filters help reduce the background sky brightness, thus increasing contrast.

Seeing Conditions

Viewing conditions affect what you can see through your telescope during an observing session. Conditions include transparency, sky illumination, and seeing. Understanding viewing conditions and the effect they have on observing will help you get the most out of your telescope.

Transparency

Transparency is the clarity of the atmosphere which is affected by clouds, moisture, and other airborne particles. Thick cumulus clouds are completely opaque while cirrus can be thin, allowing the light from the brightest stars through. Hazy skies absorb more light than clear skies making fainter objects harder to see and reducing contrast on brighter objects. Aerosols ejected into the upper atmosphere from volcanic eruptions also affect transparency. Ideal conditions are when the night sky is inky black.

Sky Illumination

General sky brightening caused by the Moon, aurorae, natural airglow, and light pollution greatly affect transparency. While not a problem for the brighter stars and planets, bright skies reduce the contrast of extended nebulae making them difficult, if not impossible, to see. To maximize your observing, limit deep sky viewing to moonless nights far from the light polluted skies found around major urban areas. LPR filters enhance deep sky viewing from light polluted areas by blocking unwanted light while transmitting light from certain deep sky objects. You can, on the other hand, observe planets and stars from light polluted areas or when the Moon is out.

Seeing

Seeing conditions refers to the stability of the atmosphere and directly affects the amount of fine detail seen in extended objects. The air in our atmosphere acts as a lens which bends and distorts incoming light rays. The amount of bending depends on air density. Varying temperature layers have different densities and, therefore, bend light differently. Light rays from the same object arrive slightly displaced creating an imperfect or smeared image. These atmospheric disturbances vary from time-to-time and place-to-place. The size of the air parcels compared to your aperture determines the "seeing" quality. Under good seeing conditions, fine detail is visible on the brighter planets like Jupiter and Mars, and stars are pinpoint images. Under poor seeing conditions, images are blurred and stars appear as blobs.

The conditions described here apply to both visual and photographic observations.



Figure 7-1

Seeing conditions directly affect image quality. These drawings represent a point source (i.e., star) under bad seeing conditions (left) to excellent conditions (right). Most often, seeing conditions produce images that lie some where between these two extremes.



Telescope Maintenance

While your NexStar telescope requires little maintenance, there are a few things to remember that will ensure your telescope performs at its best.

Care and Cleaning of the Optics

Occasionally, dust and/or moisture may build up on the corrector plate of your telescope. Special care should be taken when cleaning any instrument so as not to damage the optics.

If dust has built up on the corrector plate, remove it with a brush (made of camel's hair) or a can of pressurized air. Spray at an angle to the lens for approximately two to four seconds. Then, use an optical cleaning solution and white tissue paper to remove any remaining debris. Apply the solution to the tissue and then apply the tissue paper to the lens. Low pressure strokes should go from the center of the corrector to the outer portion. **Do NOT rub in circles!**

You can use a commercially made lens cleaner or mix your own. A good cleaning solution is isopropyl alcohol mixed with distilled water. The solution should be 60% isopropyl alcohol and 40% distilled water. Or, liquid dish soap diluted with water (a couple of drops per one quart of water) can be used.

Occasionally, you may experience dew build-up on the corrector plate of your telescope during an observing session. If you want to continue observing, the dew must be removed, either with a hair dryer (on low setting) or by pointing the telescope at the ground until the dew has evaporated.

If moisture condenses on the inside of the corrector, remove the accessories from the rear cell of the telescope. Place the telescope in a dust-free environment and point it down. This will remove the moisture from the telescope tube.

To minimize the need to clean your telescope, replace all lens covers once you have finished using it. Since the rear cell is NOT sealed, the cover should be placed over the opening when not in use. This will prevent contaminants from entering the optical tube.

Internal adjustments and cleaning should be done only by the Celestron repair department. If your telescope is in need of internal cleaning, please call the factory for a return authorization number and price quote.



Figure 8-1
The three collimation screws are located on the secondary mirror holder in the center of the corrector plate.

Collimation

The optical performance of your NexStar telescope is directly related to its collimation, that is the alignment of its optical system. Your NexStar was collimated at the factory after it was completely assembled. However, if the telescope is dropped or jarred severely during transport, it may have to be collimated. The only optical element that may need to be adjusted, or is possible, is the tilt of the secondary mirror.

To check the collimation of your telescope you will need a light source. A bright star near the zenith is ideal since there is a minimal amount of atmospheric distortion. Make sure that tracking is on so that you won't have to manually track the star. Or, if you do not want to power up your telescope, you can use Polaris. Its position relative to the celestial pole means that it moves very little thus eliminating the need to manually track it.

Before you begin the collimation process, be sure that your telescope is in thermal equilibrium with the surroundings. Allow 45 minutes for the telescope to reach equilibrium if you move it between large temperature extremes.

To verify collimation, view a star near the zenith. Use a medium to high power ocular — 12mm to 6mm focal length. It is important to center a star in the center of the field to judge collimation. Slowly cross in and out of focus and judge the symmetry of the star. If you see a systematic skewing of the star to one side, then recollimation is needed.

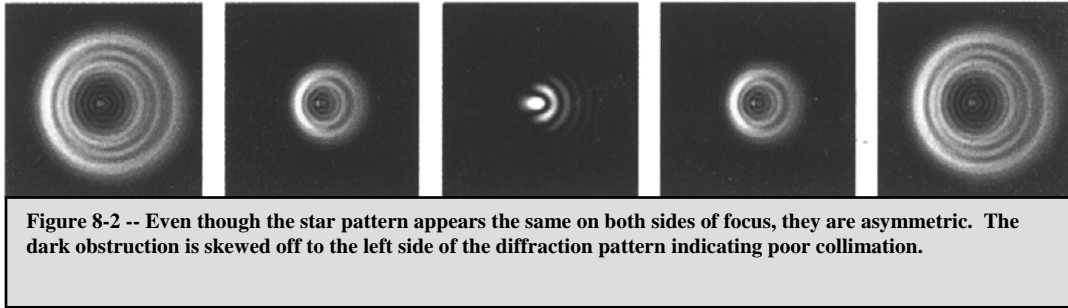

To accomplish this, you need to tighten the secondary collimation screw(s) that move the star across the field toward the direction of the skewed light. These screws are located in the secondary mirror holder (see figure 8-1). To access the collimation screws you will need to remove the cap that covers the secondary mirror holder. To remove the cap, gently slide a flat head screwdriver underneath one end of the cap and twist the screwdriver. Slide the screwdriver underneath the other side of the cap and twist until the cap comes off. Make only small 1/6 to 1/8 adjustments to the collimation screws and re-center the star by moving the scope before making any improvements or before making further adjustments.

To make collimation a simple procedure, follow these easy steps:

1. While looking through a medium to high power eyepiece, de-focus a bright star until a ring pattern with a dark shadow appears (see figure 8-2). Center the de-focused star and notice in which direction the central shadow is skewed.
2. Place your finger along the edge of the front cell of the telescope (be careful not to touch the corrector plate), pointing towards the collimation screws. The shadow of your finger should be visible when looking into the eyepiece. Rotate your finger around the tube edge until its shadow is seen closest to the narrowest portion of the rings (i.e. the same direction in which the central shadow is skewed).
3. Locate the collimation screw closest to where your finger is positioned. This will be the collimation screw you will need to adjust first. (If your finger is positioned exactly between two of the collimation screws, then you will need to adjust the screw opposite where your finger is located).
4. Use the hand control buttons to move the de-focused star image to the edge of the field of view, in the same direction that the central obstruction of the star image is skewed.

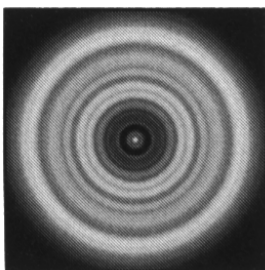

Figure 7-3
A collimated telescope should appear symmetrical with the central obstruction centered in the star's diffraction pattern.

5. While looking through the eyepiece, use an Allen wrench to turn the collimation screw you located in step 2 and 3. Usually a tenth of a turn is enough to notice a change in collimation. If the star image moves out of the field of view in the direction that the central shadow is skewed, than you are turning the collimation screw the wrong way. Turn the screw in the opposite direction, so that the star image is moving towards the center of the field of view.
6. If while turning you notice that the screws get very loose, then simply tighten the other two screws by the same amount. Conversely, if the collimation screw gets too tight, then loosen the other two screws by the same amount.
7. Once the star image is in the center of the field of view, check to see if the rings are concentric. If the central obstruction is still skewed in the same direction, then continue turning the screw(s) in the same direction. If you find that the ring pattern is skewed in a different direction, than simply repeat steps 2 through 6 as described above for the new direction.

Perfect collimation will yield a star image very symmetrical just inside and outside of focus. In addition, perfect collimation delivers the optimal optical performance specifications that your telescope is built to achieve.

If seeing (i.e., air steadiness) is turbulent, collimation is difficult to judge. Wait until a better night if it is turbulent or aim to a steadier part of the sky. A steadier part of the sky is judged by steady versus twinkling stars.

CELESTRON Optional Accessories

You will find that additional accessories enhance your viewing pleasure and expand the usefulness of your telescope. For ease of reference, all the accessories are listed in alphabetical order.

Adapter, Car Battery (#18769) -



Celestron offers the Car Battery Adapter that allows you to run the NexStar drive off an external power source. The adapter attaches to the cigarette lighter of your car, truck, van, or motorcycle.

Barlow Lens - A Barlow lens is a negative lens that increases the focal length of a telescope. Used with any eyepiece, it doubles the magnification of that eyepiece. Celestron offers two Barlow lens in the 1-1/4" size for the NexStar. The 2x Ultima Barlow (#93506) is a compact triplet design that is fully multicoated for maximum light transmission and parfocal when used with the Ultima eyepieces. Model #93507 is a compact achromatic Barlow lens that is under three inches long and weighs only 4 oz. It works very well with all Celestron eyepieces.

Diagonal, 45 degree, erect image (#94112-A) – This design allows you to look into the telescope at a 45° angle, at images that are oriented properly, meaning the image is upright and correct from left to right.

Eyepieces - Like telescopes, eyepieces come in a variety of designs. Each design has its own advantages. For the 1-1/4" barrel diameter there are three different eyepiece designs available:

- **OMNI Plössl** - Plössl eyepieces have a 4-element lens designed for low-to-high power observing. The Plössls offer razor sharp views across the entire field, even at the edges! In the 1-1/4" barrel diameter, they are available in the following focal lengths: 4mm, 6mm, 9mm, 12.5mm, 15mm, 20mm, 25mm, 32mm and 40mm.
- **X-Cel** - This 6 element design allows each X-Cel Eyepiece to have 20mm of eye relief, 55° field of view and more than 25mm of lens aperture (even with the 2.3mm). In order to maintain razor sharp, color corrected images across its 50° field of view, extra-low dispersion glass is used for the most highly curved optical elements. The excellent refractive properties of these high grade optical elements, make the X-Cel line especially well suited for high magnification planetary viewing where sharp, color-free views are most appreciated. X-Cel eyepieces come in the following focal lengths: 2.3mm, 5mm, 8mm, 10mm, 12.5mm, 18mm, 21mm, 25mm.
- **Ultima** - Ultima is not really a design, but a trade name for our 5-element, wide field eyepieces. In the 1-1/4" barrel diameter, they are available in the following focal lengths: 5mm, 7.5mm, 10mm, 12.5mm, 18mm, 30mm, 35mm, and 42mm. These eyepieces are all parfocal.



Exotherm, Hand Warmer- (#93504) - Perfect for chilly evenings of star gazing, the Exotherm Hand Warmer is convenient, reusable and provides up to one hour of instant heat.

Filters, Eyepiece - To enhance your visual observations of solar system objects, Celestron offers a wide range of colored eyepiece filter sets that thread into the 1-1/4" oculars. Available sets are:

#94119-10 – Orange, Light Blue, ND13%T, Polarizing (#s 21, 80A, 15, Polarizing)

#94119-20 - Deep Yellow, Red, Light Green, ND25% T (#s 12, 25, 56, 96ND-25)

#94119-30 - Light Red, Blue, Green, ND50% T (#s 23A, 38A, 58, 96ND-50)

#94119-40 - Yellow, Deep Yellow, Violet, Pale Blue (#s 8, 96ND-13, 47, 82A)

Night Vision Flashlight - (#93588) - Celestron's premium model for astronomy, using two red LED's to preserve night vision better than red filters or other devices. Brightness is adjustable. Operates on a single 9 volt battery (included).

Light Pollution Reduction (LPR) Filter - These filters are designed to enhance your views of deep sky astronomical objects when viewed from urban areas. LPR Filters selectively reduce the transmission of certain wavelengths of light, specifically those produced by artificial

lights. This includes mercury and high and low pressure sodium vapor lights. In addition, they also block unwanted natural light (sky glow) caused by neutral oxygen emission in our atmosphere. Celestron offers a model for 1-1/4" eyepieces (#94126A).

Moon Filter (#94119-A) - Celestron's Moon Filter is an economical eyepiece filter for reducing the brightness of the moon and improving contrast, so greater detail can be observed on the lunar surface. The clear aperture is 21mm and the transmission is about 18%.

Polarizing Filter Set (#93608) - The polarizing filter set limits the transmission of light to a specific plane, thus increasing contrast between various objects. This is used primarily for terrestrial, lunar and planetary observing.

PowerTank (#18774) - 12v 7Amp hour rechargeable power supply. Comes with two 12v output cigarette outlets, built-in red flash light, Halogen emergency spotlight, AC adapter and cigarette lighter adapter included.



Sky Maps (#93722) - Celestron Sky Maps are the ideal teaching guide for learning the night sky. You wouldn't set off on a road trip without a road map, and you don't need to try to navigate the night sky without a map either. Even if you already know your way around the major constellations, these maps can help you locate all kinds of fascinating objects.

Solar Filter (#94139) - The AstroSolar® filter is a safe and durable filter that covers the front opening of the telescope. View sunspots and other solar features using this double-sided metal coated filter for uniform density and good color balance across the entire field. The Sun offers constant changes and will keep your observing interesting and fun.

T-Adapter (#93633-A) - T-Adapter (with additional T-Ring) allows you to attach your SLR camera to the rear cell of your Celestron NexStar. This turns your NexStar into a 1250mm telephoto lens perfect for terrestrial photography and short exposure lunar and filtered solar photography.

T-Ring - The T-Ring couples your 35mm SLR camera body to the T-Adapter. This accessory is mandatory if you want to do photography through the telescope. Each camera make (i.e., Minolta, Nikon, Pentax, etc.) has its own unique mount and therefore, its own T-Ring. Celestron has 8 different models for 35mm cameras.

Vibration Suppression Pads (#93503) - These pads rest between the ground and tripod feet of your telescope. They reduce the amplitude and vibration time of your telescope when shaken by the wind or an accidental bump. This accessory is a must for long exposure prime focus photography.

A full description of all Celestron accessories can be found in the Celestron Accessory Catalog (#93685).

Appendix A - Technical Specifications

Optical Specification

Design	Schmidt Cassegrain Optical Design
Aperture	5 inches (125mm)
Focal Length	50 inches (1250mm)
F/ratio of the Optical System	10
Primary Mirror: Diameter Coatings	125mm Starbright XLT®
Secondary Mirror Spot Size Secondary Obstruction	1.75" 35% by diameter; 12% by area
Corrector Plate: Material Coatings	Optical Quality Crown Glass Starbright XLT®
Highest Useful Magnification	300x
Lowest Useful Magnification (7mm exit pupil)	18x
Resolution: Rayleigh Criterion Dawes Limit	1.11 arc seconds .91 arc seconds
Light Gathering Power	329x unaided eye
Near Focus standard eyepiece or camera	~ 20 feet
Field of View: Standard Eyepiece : 35mm Camera	1° 1.6° x 1.1°
Linear Field of View (at 1000 yds)	52.5 feet
Magnification: Standard Eyepiece	50x
Optical Tube Length	11 inches
Weight of Telescope	17.6 Lbs.
Weight of Tripod	10 lbs

Electronic Specifications

Input Voltage	12 V DC Nominal
Batteries Required	8 AA Alkaline
Power Supply Requirements	12 VDC-750 mA (Tip positive)

Mechanical Specifications

Motor: Type Resolution	DC Servo motors with encoders, both axes .26 arc sec
Slew speeds	Nine slew speeds: 4°/sec, 2°/sec, 1°/sec, .5/sec, 32x, 16x, 8x, 4x, 2x
Hand Control	Double line, 16 character Liquid Crystal Display 19 fiber optic backlit LED buttons
Fork Arm	Cast aluminum, with integrated hand control receptacle

Software Specifications

Software Precision	16 bit, 20 arc sec. calculations
Ports	RS-232 communication port on hand control
Tracking Rates	Sidereal, Solar, Lunar and King
Tracking Modes	Alt-Az, EQ North & EQ South
Alignment Procedures	SkyAlign, Auto Two-Star, Two-Star, One-Star, Solar System Align
Database	200 user defined programmable object. Enhanced information on over 200 objects
Total Object Database	38,181

Appendix B - Glossary of Terms

A-

Absolute magnitude	The apparent magnitude that a star would have if it were observed from a standard distance of 10 parsecs, or 32.6 light-years. The absolute magnitude of the Sun is 4.8. at a distance of 10 parsecs, it would just be visible on Earth on a clear moonless night away from surface light.
Airy disk	The apparent size of a star's disk produced even by a perfect optical system. Since the star can never be focused perfectly, 84 per cent of the light will concentrate into a single disk, and 16 per cent into a system of surrounding rings.
Alt-Azimuth Mounting	A telescope mounting using two independent rotation axis allowing movement of the instrument in Altitude and Azimuth.
Altitude	In astronomy, the altitude of a celestial object is its Angular Distance above or below the celestial horizon.
Aperture	the diameter of a telescope's primary lens or mirror; the larger the aperture, the greater the telescope's light-gathering power.
Apparent Magnitude	A measure of the relative brightness of a star or other celestial object as perceived by an observer on Earth.
Arcminute	A unit of angular size equal to 1/60 of a degree.
Arcsecond	A unit of angular size equal to 1/3,600 of a degree (or 1/60 of an arcminute).
Asterism	A small unofficial grouping of stars in the night sky.
Asteroid	A small, rocky body that orbits a star.
Astrology	The pseudoscientific belief that the positions of stars and planets exert an influence on human affairs; astrology has nothing in common with astronomy
Astronomical unit (AU)	The distance between the Earth and the Sun. It is equal to 149,597,900 km., usually rounded off to 150,000,000 km.
Aurora	The emission of light when charged particles from the solar wind slams into and excites atoms and molecules in a planet's upper atmosphere.
Azimuth	The angular distance of an object eastwards along the horizon, measured from due north, between the astronomical meridian (the vertical line passing through the center of the sky and the north and south points on the horizon) and the vertical line containing the celestial body whose position is to be measured. .

B -

Binary Stars	Binary (Double) stars are pairs of stars that, because of their mutual gravitational attraction, orbit around a common Center of Mass. If a group of three or more stars revolve around one another, it is called a multiple system. It is believed that approximately 50 percent of all stars belong to binary or multiple systems. Systems with individual components that can be seen separately by a telescope are called visual binaries or visual multiples. The nearest "star" to our solar system, Alpha Centauri, is actually our nearest example of a multiple star system, it consists of three stars, two very similar to our Sun and one dim, small, red star orbiting around one another.
--------------	---

C -

Celestial Equator	The projection of the Earth's equator on to the celestial sphere. It divides the sky into two equal hemispheres.
Celestial pole	The imaginary projection of Earth's rotational axis north or south pole onto the celestial sphere.
Celestial Sphere	An imaginary sphere surrounding the Earth, concentric with the Earth's center.
Collimation	The act of putting a telescope's optics into perfect alignment.

D -

Declination (DEC)	The angular distance of a celestial body north or south of the celestial equator. It may be said to correspond to latitude on the surface of the Earth.
-------------------	---

E -

Ecliptic	The projection of the Earth's orbit on to the celestial sphere. It may also be defined as "the apparent yearly path of the Sun against the stars".
Equatorial mount	A telescope mounting in which the instrument is set upon an axis which is parallel to the axis of the Earth; the angle of the axis must be equal to the observer's latitude.

F - Focal length	The distance between a lens (or mirror) and the point at which the image of an object at infinity is brought to focus. The focal length divided by the aperture of the mirror or lens is termed the focal ratio.
J - Jovian Planets	Any of the four gas giant planets that are at a greater distance from the sun than the terrestrial planets.
K - Kuiper Belt	A region beyond the orbit of Neptune extending to about 1000 AU which is a source of many short period comets.
L - Light-Year (ly)	A light-year is the distance light traverses in a vacuum in one year at the speed of 299,792 km/ sec. With 31,557,600 seconds in a year, the light-year equals a distance of 9.46 X 1 trillion km (5.87 X 1 trillion mi).
M - Magnitude	Magnitude is a measure of the brightness of a celestial body. The brightest stars are assigned magnitude 1 and those increasingly fainter from 2 down to magnitude 5. The faintest star that can be seen without a telescope is about magnitude 6. Each magnitude step corresponds to a ratio of 2.5 in brightness. Thus a star of magnitude 1 is 2.5 times brighter than a star of magnitude 2, and 100 times brighter than a magnitude 5 star. The brightest star, Sirius, has an apparent magnitude of -1.6, the full moon is -12.7, and the Sun's brightness, expressed on a magnitude scale, is -26.78. The zero point of the apparent magnitude scale is arbitrary.
Meridian	A reference line in the sky that starts at the North celestial pole and ends at the South celestial pole and passes through the zenith. If you are facing South, the meridian starts from your Southern horizon and passes directly overhead to the North celestial pole.
Messier	A French astronomer in the late 1700's who was primarily looking for comets. Comets are hazy diffuse objects and so Messier cataloged objects that were not comets to help his search. This catalog became the Messier Catalog, M1 through M110.
N - Nebula	Interstellar cloud of gas and dust. Also refers to any celestial object that has a cloudy appearance.
North Celestial Pole	The point in the Northern hemisphere around which all the stars appear to rotate. This is caused by the fact that the Earth is rotating on an axis that passes through the North and South celestial poles. The star Polaris lies less than a degree from this point and is therefore referred to as the "Pole Star".
Nova	Although Latin for "new" it denotes a star that suddenly becomes explosively bright at the end of its life cycle.
O - Open Cluster	One of the groupings of stars that are concentrated along the plane of the Milky Way. Most have an asymmetrical appearance and are loosely assembled. They contain from a dozen to many hundreds of stars.
P - Parallax	Parallax is the difference in the apparent position of an object against a background when viewed by an observer from two different locations. These positions and the actual position of the object form a triangle from which the apex angle (the parallax) and the distance of the object can be determined if the length of the baseline between the observing positions is known and the angular direction of the object from each position at the ends of the baseline has been measured. The traditional method in astronomy of determining the distance to a celestial object is to measure its parallax.
Parfocal	Refers to a group of eyepieces that all require the same distance from the focal plane of the telescope to be in focus. This means when you focus one parfocal eyepiece all the other parfocal eyepieces, in a particular line of eyepieces, will be in focus.
Parsec	The distance at which a star would show parallax of one second of arc. It is equal to 3.26 light-years, 206,265 astronomical units, or 30,8000,000,000,000 km. (Apart from the Sun, no star lies within one parsec of us.)
Point Source	An object which cannot be resolved into an image because it is too far away or too small is considered a point source. A planet is far away but it can be resolved as a disk. Most stars cannot be resolved as disks, they are too far away.
R - Reflector	A telescope in which the light is collected by means of a mirror.

Resolution	The minimum detectable angle an optical system can detect. Because of diffraction, there is a limit to the minimum angle, resolution. The larger the aperture, the better the resolution.
Right Ascension: (RA)	The angular distance of a celestial object measured in hours, minutes, and seconds along the Celestial Equator eastward from the Vernal Equinox.
S -	
Sidereal Rate	This is the angular speed at which the Earth is rotating. Telescope tracking motors drive the telescope at this rate. The rate is 15 arc seconds per second or 15 degrees per hour.
T -	
Terminator	The boundary line between the light and dark portion of the moon or a planet.
U -	
Universe	The totality of astronomical things, events, relations and energies capable of being described objectively.
V -	
Variable Star	A star whose brightness varies over time due to either inherent properties of the star or something eclipsing or obscuring the brightness of the star.
W -	
Waning Moon	The period of the moon's cycle between full and new, when its illuminated portion is decreasing.
Waxing Moon	The period of the moon's cycle between new and full, when its illuminated portion is increasing.
Z -	
Zenith	The point on the Celestial Sphere directly above the observer.
Zodiac	The zodiac is the portion of the Celestial Sphere that lies within 8 degrees on either side of the Ecliptic. The apparent paths of the Sun, the Moon, and the planets, with the exception of some portions of the path of Pluto, lie within this band. Twelve divisions, or signs, each 30 degrees in width, comprise the zodiac. These signs coincided with the zodiacal constellations about 2,000 years ago. Because of the Precession of the Earth's axis, the Vernal Equinox has moved westward by about 30 degrees since that time; the signs have moved with it and thus no longer coincide with the constellations.

Appendix C - RS-232 Connection

Using the included NexRemote software you can control your NexStar telescope with a computer via the RS-232 port located on the computerized hand control and using the RS-232 cable . For information about using NexRemote to control your telescope, refer to the help files located on the disk. In addition to NexRemote, the telescope can be controlled using other popular astronomy software programs.

Appendix D – Maps of Time Zones

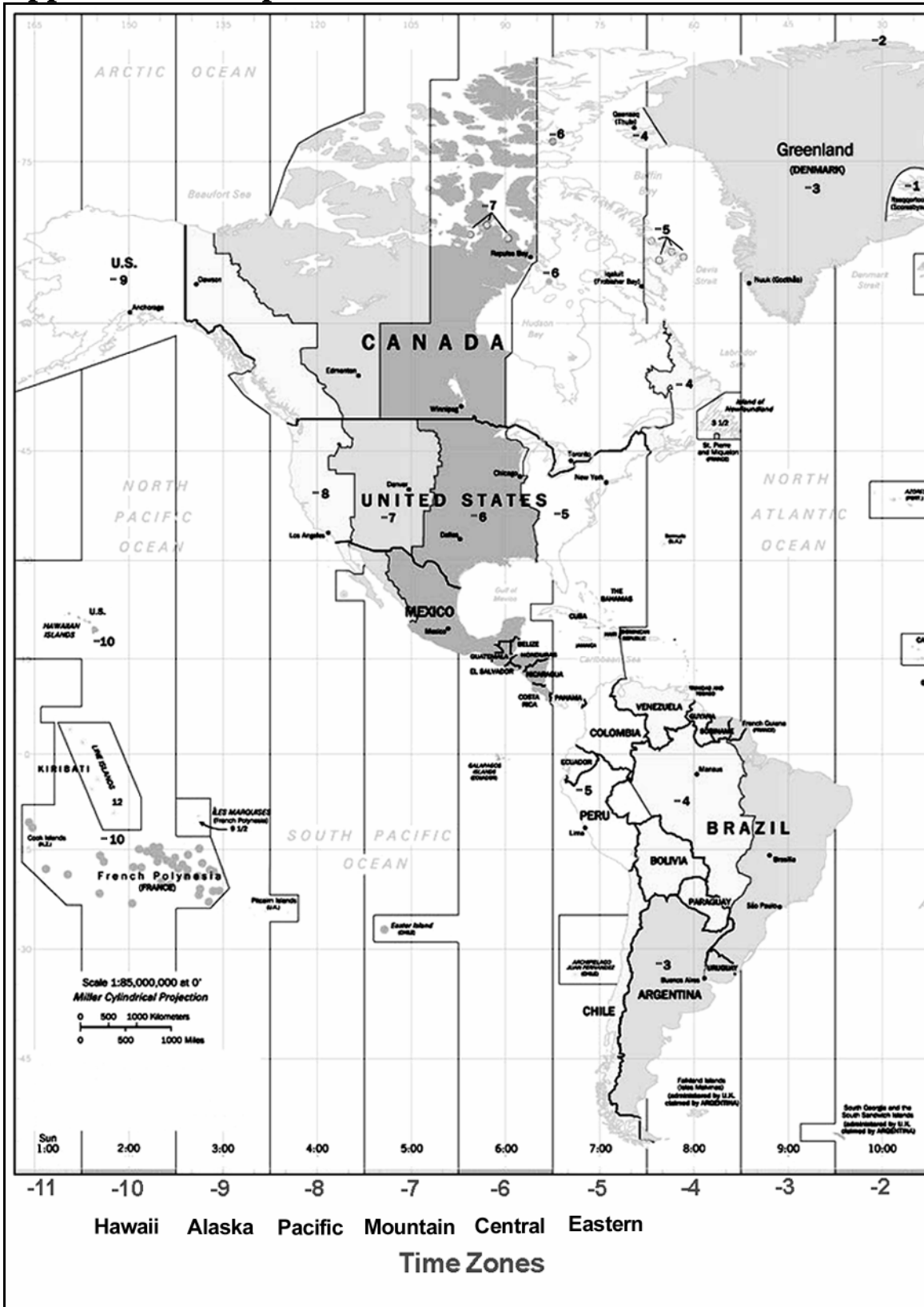

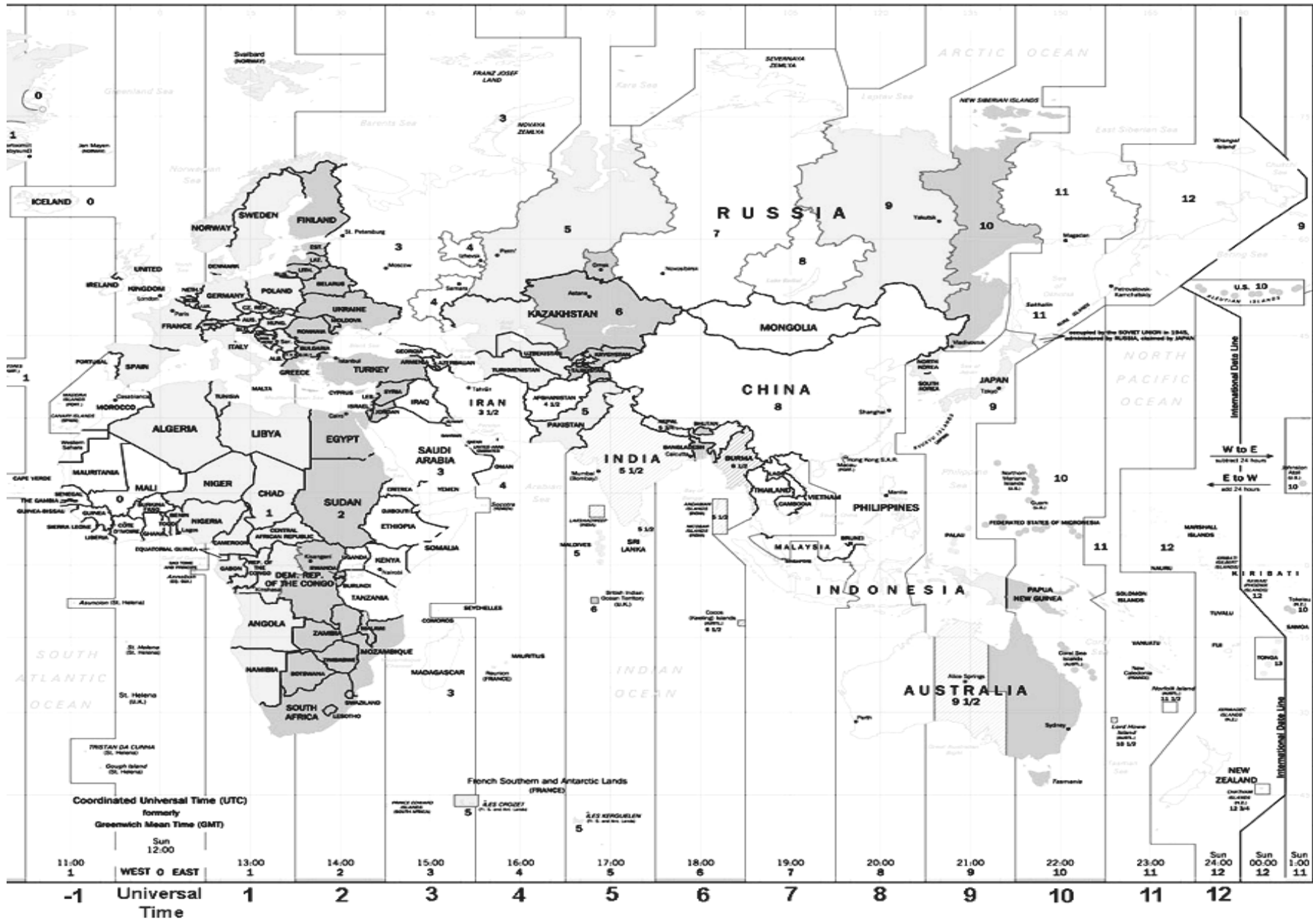

Time Zones

January - February Sky

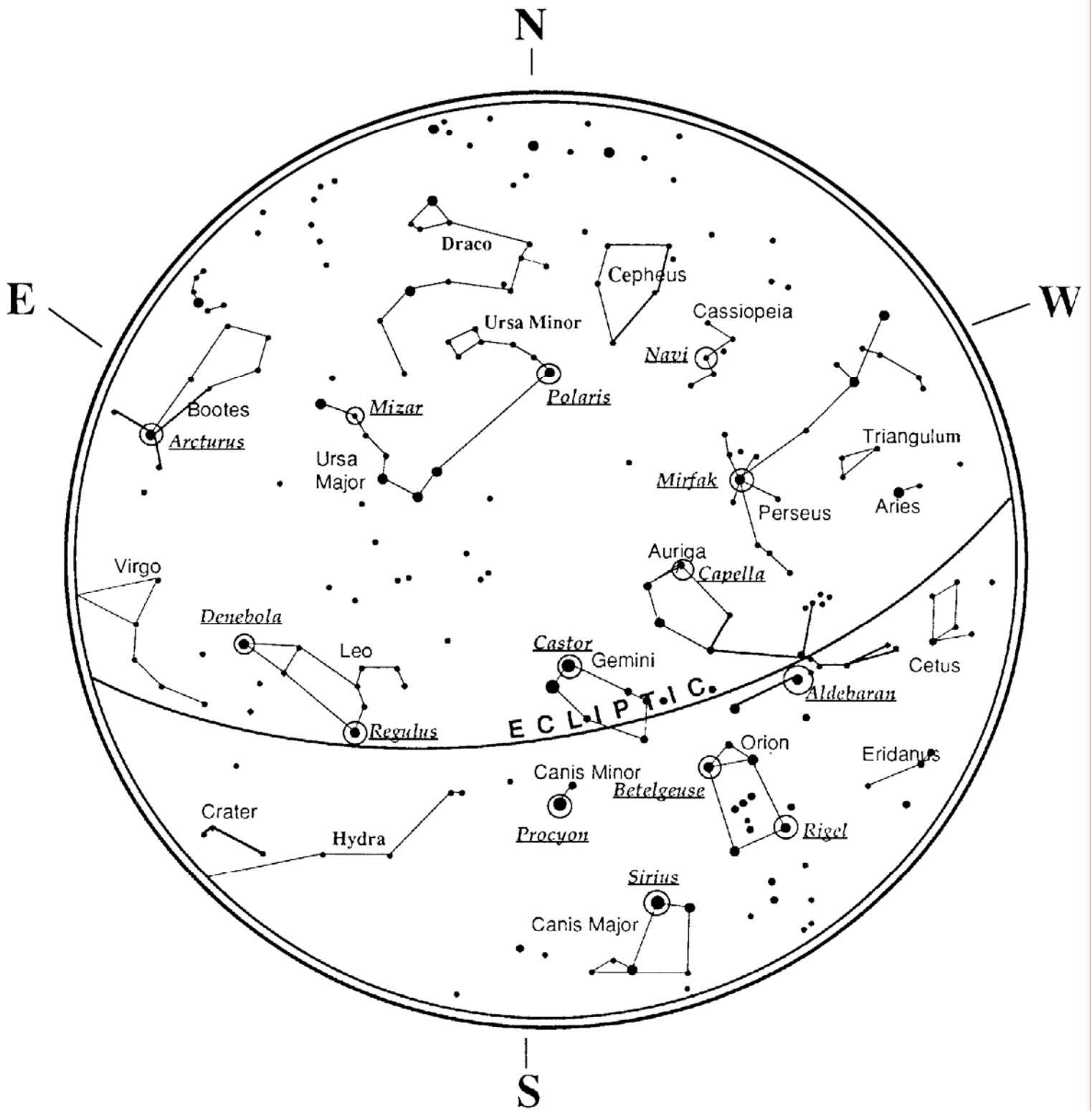

March - April Sky

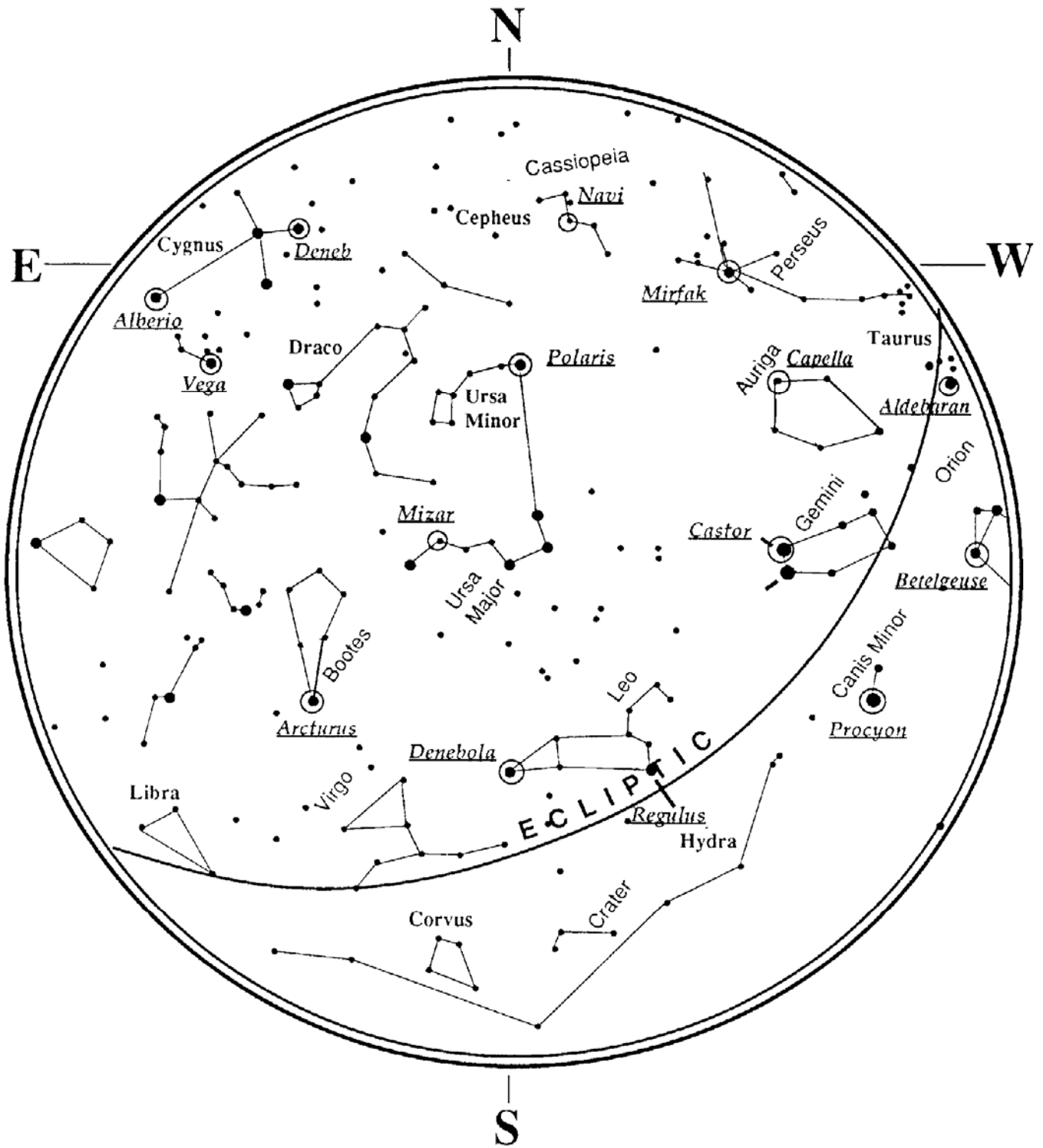

May - June Sky

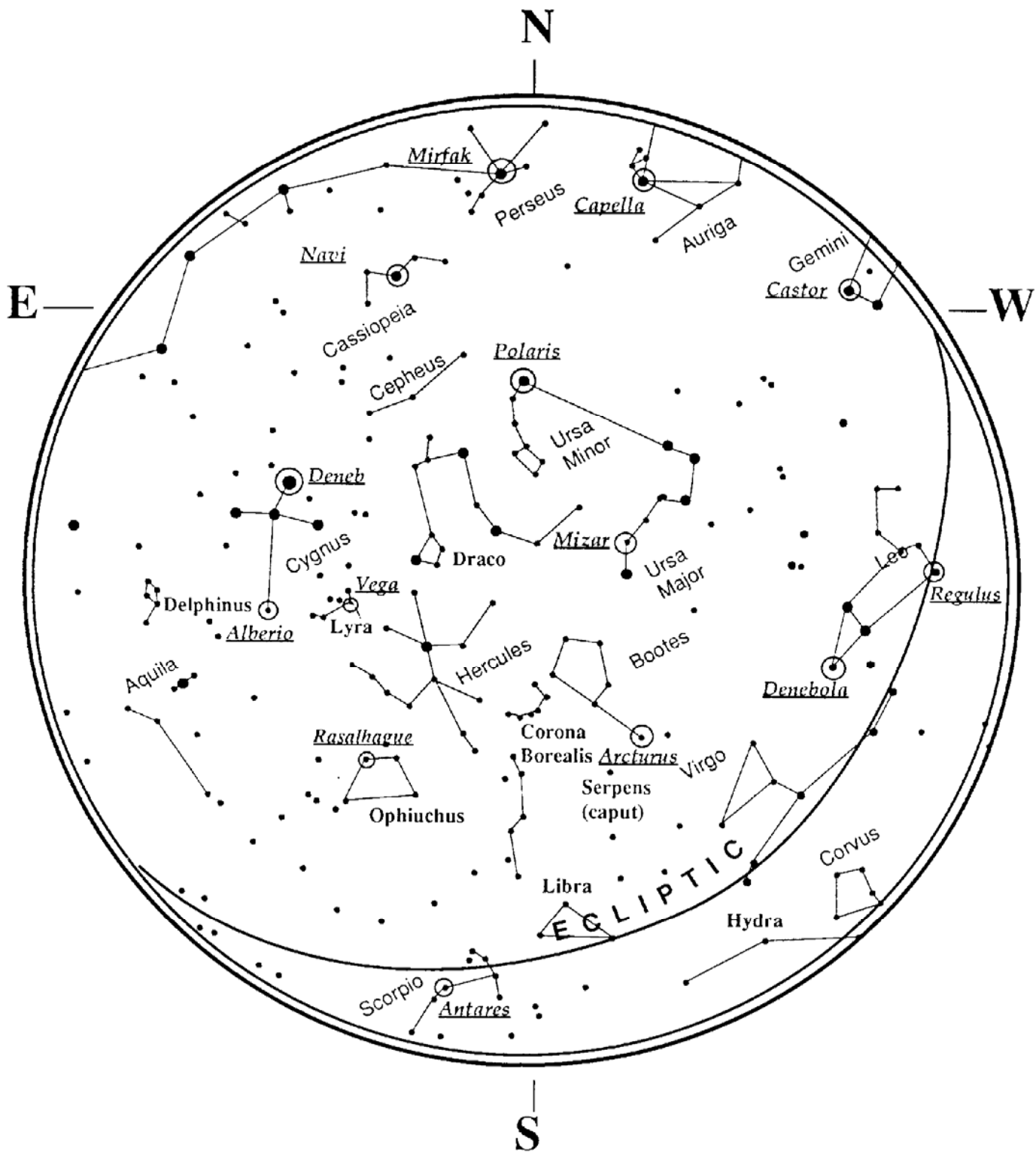

July - August Sky

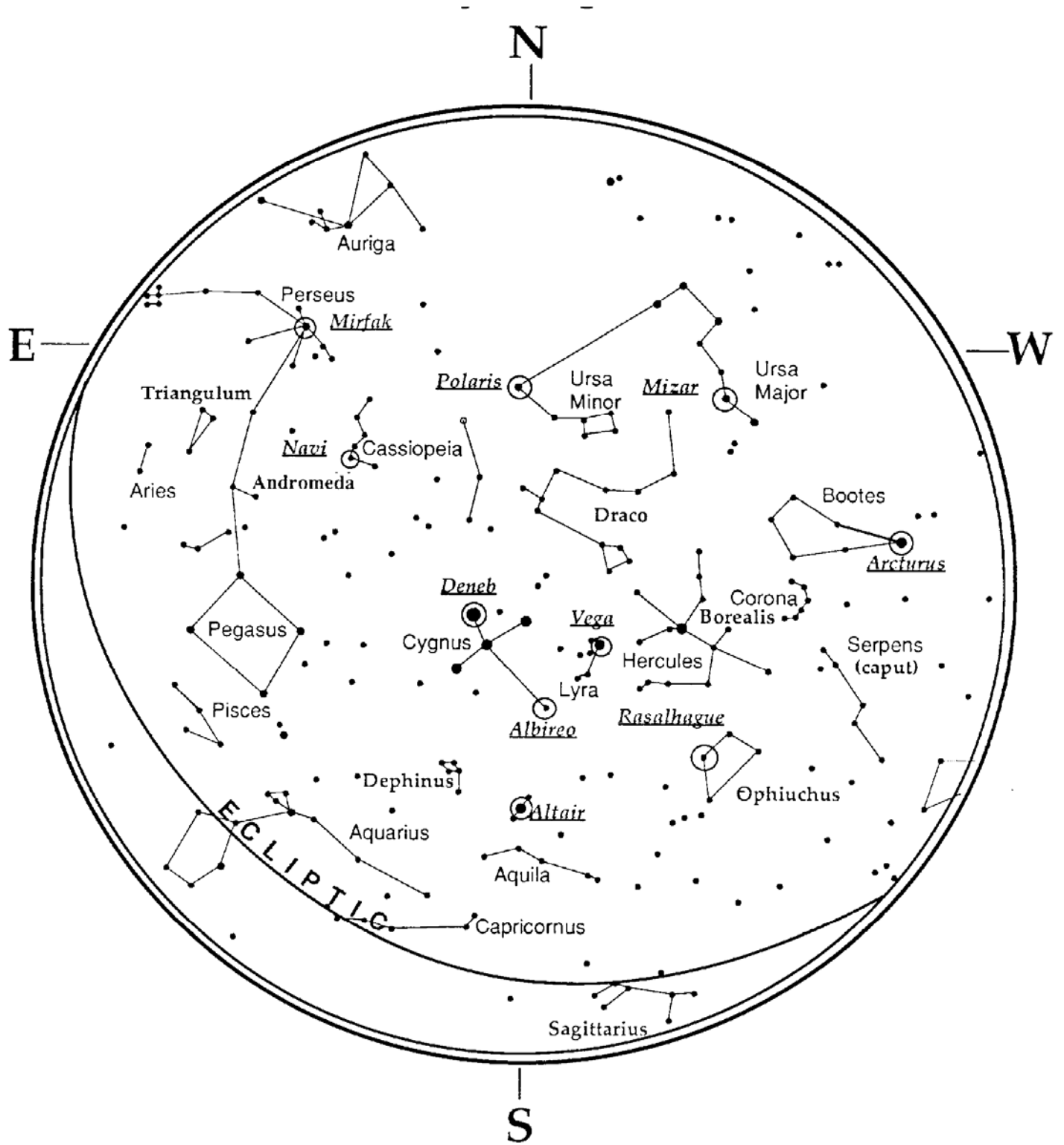

September - October Sky

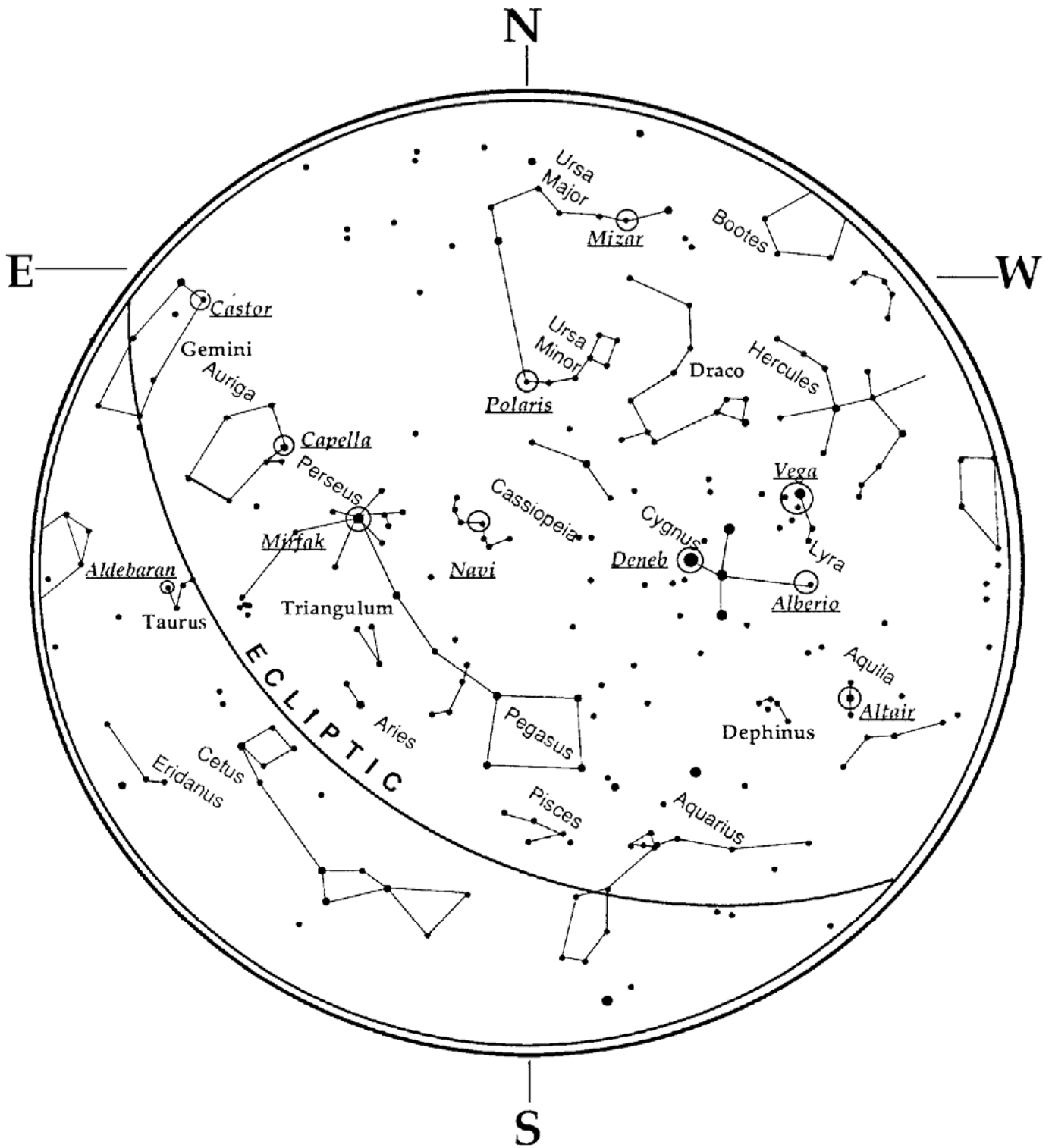

November - December Sky

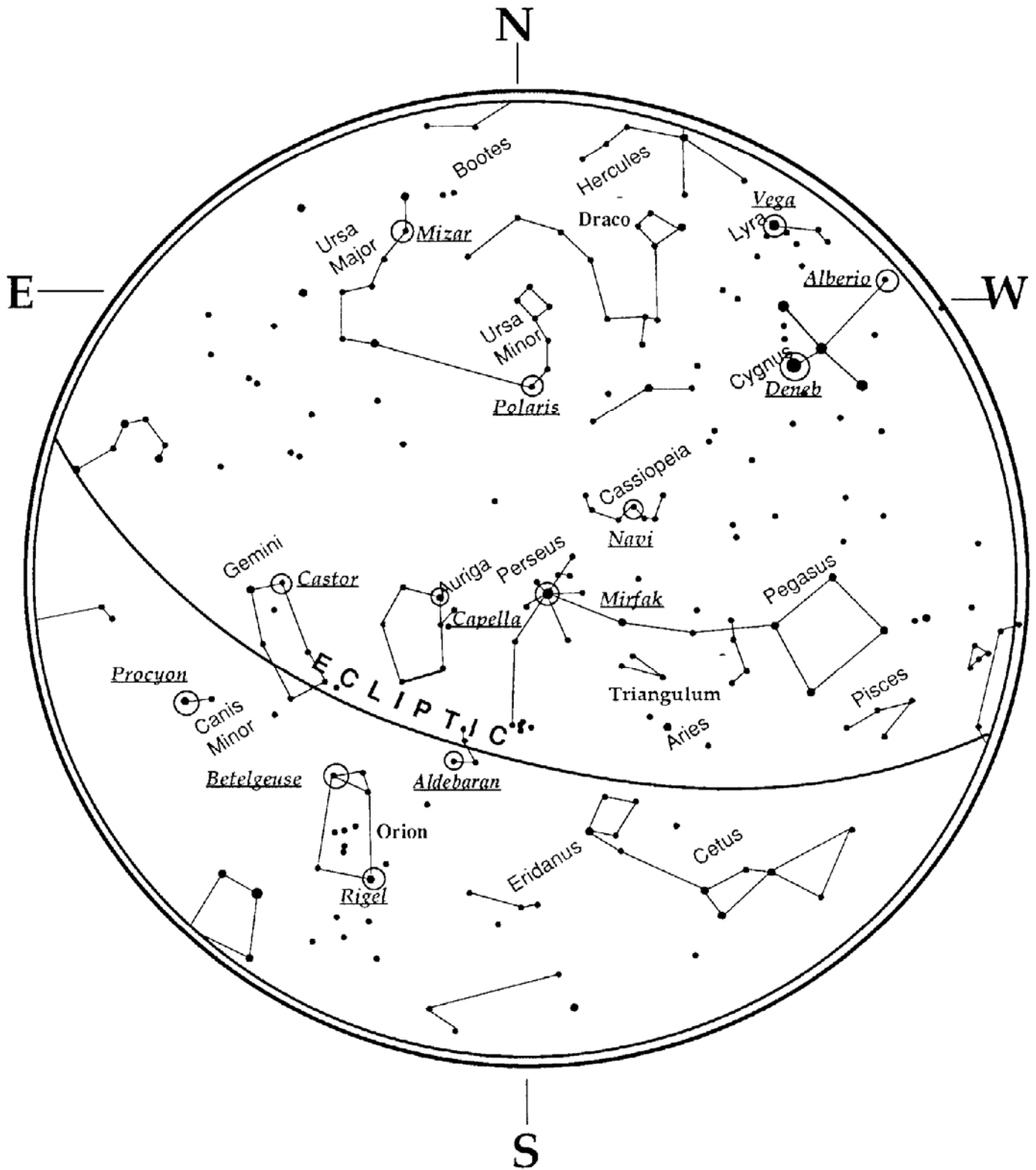

CELESTRON TWO YEAR WARRANTY

A. Celestron warrants this telescope to be free from defects in materials and workmanship for two years. Celestron will repair or replace such product or part thereof which, upon inspection by Celestron, is found to be defective in materials or workmanship. As a condition to the obligation of Celestron to repair or replace such product, the product must be returned to Celestron together with proof-of-purchase satisfactory to Celestron.

B. The Proper Return Authorization Number must be obtained from Celestron in advance of return. Call Celestron at (310) 328-9560 to receive the number to be displayed on the outside of your shipping container.

All returns must be accompanied by a written statement setting forth the name, address, and daytime telephone number of the owner, together with a brief description of any claimed defects. Parts or product for which replacement is made shall become the property of Celestron.

The customer shall be responsible for all costs of transportation and insurance, both to and from the factory of Celestron, and shall be required to prepay such costs.

Celestron shall use reasonable efforts to repair or replace any telescope covered by this warranty within thirty days of receipt. In the event repair or replacement shall require more than thirty days, Celestron shall notify the customer accordingly. Celestron reserves the right to replace any product which has been discontinued from its product line with a new product of comparable value and function.

This warranty shall be void and of no force of effect in the event a covered product has been modified in design or function, or subjected to abuse, misuse, mishandling or unauthorized repair. Further, product malfunction or deterioration due to normal wear is not covered by this warranty.

CELESTRON DISCLAIMS ANY WARRANTIES, EXPRESS OR IMPLIED, WHETHER OF MERCHANTABILITY OF FITNESS FOR A PARTICULAR USE, EXCEPT AS EXPRESSLY SET FORTH HEREIN.

THE SOLE OBLIGATION OF CELESTRON UNDER THIS LIMITED WARRANTY SHALL BE TO REPAIR OR REPLACE THE COVERED PRODUCT, IN ACCORDANCE WITH THE TERMS SET FORTH HEREIN. CELESTRON EXPRESSLY DISCLAIMS ANY LOST PROFITS, GENERAL, SPECIAL, INDIRECT OR CONSEQUENTIAL DAMAGES WHICH MAY RESULT FROM BREACH OF ANY WARRANTY, OR ARISING OUT OF THE USE OR INABILITY TO USE ANY CELESTRON PRODUCT. ANY WARRANTIES WHICH ARE IMPLIED AND WHICH CANNOT BE DISCLAIMED SHALL BE LIMITED IN DURATION TO A TERM OF TWO YEARS FROM THE DATE OF ORIGINAL RETAIL PURCHASE.

Some states do not allow the exclusion or limitation of incidental or consequential damages or limitation on how long an implied warranty lasts, so the above limitations and exclusions may not apply to you.

This warranty gives you specific legal rights, and you may also have other rights which vary from state to state.

Celestron reserves the right to modify or discontinue, without prior notice to you, any model or style telescope.

If warranty problems arise, or if you need assistance in using your telescope contact:

Celestron
Customer Service Department
2835 Columbia Street
Torrance, CA 90503
Tel. (310) 328-9560
Fax. (310) 212-5835
Monday-Friday 8AM-4PM PST

This warranty supersedes all other product warranties.

NOTE: This warranty is valid to U.S.A. and Canadian customers who have purchased this product from an Authorized Celestron Dealer in the U.S.A. or Canada. Warranty outside the U.S.A. and Canada is valid only to customers who purchased from a Celestron Distributor or Authorized Celestron Dealer in the specific country and please contact them for any warranty service.



Celestron
2835 Columbia Street
Torrance, CA 90503
Tel. (310) 328-9560
Fax. (310) 212-5835
Web site at <http://www.celestron.com>

Copyright 2006 Celestron
All rights reserved.

(Products or instructions may change
without notice or obligation.)

This device complies with Part 15 of the FCC Rule. Operation is subject to the following two conditions: 1) This device may not cause harmful interference, and 2) This device must accept any interference received, including interference that may cause undesired operations.

#11036-INST
Printed in China
\$10.00
06-06